

PRICELIST 2024

**A story of glass
and light.**

The logo features a stylized, elegant cursive 'C' followed by the text '. CANGINI & TUCCI' in a clean, sans-serif font. A registered trademark symbol (®) is positioned at the end of the text.

LIGHTING COLLECTION 2024

**A story of glass
and light.**

 . CANGINI & TUCCI®

Dear customer,
thank you for choosing Cangini and Tucci's product.
In order to improve our service, find listed below the instructions to place your order:

- Always write the code followed by the colour of the glass, example:
ZOE® 1303.1L
glass: TRANSPARENT (01)
- Specify the finish of the structure (where possible), example:
PIT® 1583.1L
structure: satin black nickel
- Specify the colour of the electric cable (where possible), example:
ECLISSE® 1293.1L glass TOBACCO (16)
with RED cable
- Specify if you would like a different lamp holder (where available), example:
LACRIMA® 1253.1L with E14
with E27 lamp holder
- Specify the light colour temperature (where possible), example:
PIT® 1583.1L
with LED: 2700°K

For special compositions, it is advisable to consult us for confirmation of the feasibility and price.

Please be informed that the items not included in the catalogue, since out of production, can be still provided on request (if still possible). We invite you to contact the company for a quotation.

To purchase only the canopy/track/plate etc. Go to page 89 of the price list.

On request we can provide custom projects.

ADDITIONAL INFORMATION:



The prices with G9, E14 and E27 lamp holders indicated in the price list do not include bulbs.

Tracks and plates are supplied in POLISHED STAINLESS STEEL.

RESPECT THE COLOUR CHART IN OUR CATALOGUE AVAILABLE FOR EACH PRODUCT
(only on products GIG XXL and MAX in fume (08) colour: 10% surcharge on the price of the coloured)

On request with **UL COMPONENTS**: 10% surcharge.

CANGINI & TUCCI®
Wan

LEGAL DISCLAIMER

This pricelist contains visual representations and drawings of products and/or works that are protected under national and international intellectual and industrial property law.

© All rights reserved.

The visual representations and drawings of these products and/or works are not to be utilised, reproduced, communicated, disseminated and/or transmitted in any form whatsoever, by any means – be it electronic, mechanical or otherwise – without the express authorisation of the owner of the rights.

Some of the products and/or works presented in this catalogue are registered as industrial models, industrial designs and/or trademarks. Any violation will be prosecuted by any means made available by the Italian and international legal system.

RECHTLICHE HINWEISE

Die vorliegende Preisliste enthält die grafischen Darstellungen und Zeichnungen der Produkte und/oder Werke, die durch nationale und übernationale Gesetze zum geistigen und gewerblichen Eigentum geschützt sind.

© Alle Rechte vorbehalten.

Die grafischen Darstellungen und Zeichnungen dieser Produkte und/oder Werke dürfen nicht verwendet, reproduziert, übermittelt, verbreitet und/oder in irgendeiner Form, auf keine Weise und/oder auf elektronische, mechanische oder andere Weise übertragen werden, ohne ausdrückliche Genehmigung des Rechteinhabers.

Einige der Produkte und/oder Werke, die in dieser Katalog präsentiert werden, sind als gewerbliche Muster, gewerbliche Zeichnungen und/oder als Marken eingetragen.

Jeder Verstoß wird mit allen Mitteln verfolgt, die vom italienischen und internationalen Rechtssystem zur Verfügung gestellt werden.

INDEX



AERON®
14



DALMA®
16



ECLISSE®
20

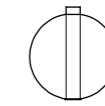

ECLISSE MAX®
22

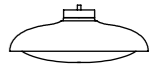

FIJI®
24



FLUTE®
28

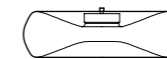

FOLD®
30



FREQUENCY®
34

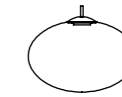

GEO®
38

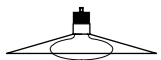

HYDRA®
40

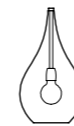

LACRIMA®
44



LA STILLA®
48

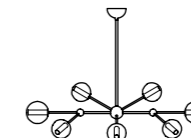

MIREA®
52

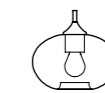

PARIGI®
54

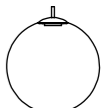

PIT®
62

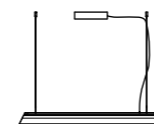

REGULA®
66

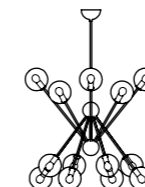

SCARLETT®
68



TAO®
70

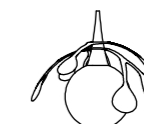

VEGETAL®
72

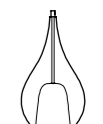

ZOE®
76

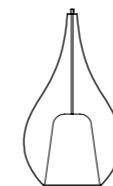

ZOE® MAX
80



ZOE VGM®
82



GUIDE TO THE CHARACTERISTICS
OF HAND-WORKED GLASS
84



COLOUR
SAMPLE KIT
88

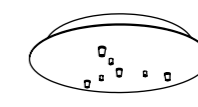

STRUCTURES FOR
COMPOSITIONS
89

METALLIZATION / METALLISIERUNG

The processing and metallization of Cangini e Tucci glass are entirely handmade by expert craftsmen. Each component is heated by flame and worked slowly, dedicating care and time to the delicate process of transformation. The added value that this process - entirely manual - gives the product is inestimable. The history of each individual glass element is also made up of small finishing imperfections, imperceptible dimensional differences that attest the diversity of each single product and, therefore, its uniqueness.

Die Verarbeitung und Metallisierung des Glases von Cangini e Tucci sind komplett von erfahrenen Handwerkern handgefertigt. Jeder Bestandteil wird über einer Flamme erhitzt und langsam verarbeitet und somit wird dem feinen Verarbeitungsprozess viel Zeit und Sorgfalt gewidmet. Der Mehrwert dieser vollständig manuellen Verarbeitung verleiht dem Produkt einen unschätzbaren Wert. Die Geschichte jedes einzelnen Glaselements besteht aus kleinen Unvollkommenheiten in der Verarbeitung mit kaum sichtbaren Maßabweichungen, die die Andersartigkeit jedes einzelnen Produkts und damit seine Einzigartigkeit belegen.



GLASS CLEANING / REINIGUNG DES GLASES

To clean the glass surface do not use abrasive products or alcohol. Use only a soft cloth with warm water, preferably distilled, avoiding excessive friction.

Für die Reinigung des Glases dürfen keine Scheuermittel oder Alkohol verwendet werden. Verwenden Sie nur ein weiches Tuch mit warmem Wasser, vorzugsweise destilliert, und vermeiden Sie übermäßiges Reiben.

CONDITIONS OF SALE

The current price list replaces all previous ones.

Prices are in € EURO without VAT.

PACKAGING

Packing costs in cardboard boxes are included in the price.

ORDERS

The confirmed order cannot be canceled, and it is not possible to send back the supplied materials except for written arrangements between the parties.

Cancellations of orders concerning special fixtures are not accepted.

The company reserves the right to make design changes to improve the products at any time and without notice.

COMPLAINTS AND RETURNS

The company is not responsible for possible breaks or losses during the transportation of its products. Any possible complaint will have to be submitted within eight days from the receipt of the goods by registered letter or by fax or by e-mail. Return of materials is not accepted unless authorized in writing beforehand; the goods have to be delivered in perfect conditions, not being used and into their original packages.

The client must CHECK the PACKAGING INTEGRITY. In case of missing signature “goods accepted under reserve” on the document, the goods will not be replaced.

INSTALLATION

All our LEDS with their own drivers are tested inside the company before the shipment. Thus, the company is not responsible for any malfunction during the installation, which might be due to negligence and not checking of mounting instructions.

RESERVE OF PROPERTY

The manufacturer is the owner of the goods till they have been fully paid.

FURTHER CLAUSES

The products with E14 E27 and G9 lampholder indicated in the pricelist do not include bulbs.

The company doesn't sell bulbs.

All models are in compliance with legal standards and regulations.

We do not take the responsibility for damages resulting from the improper use of the devices.

METAL STRUCTURE AVAILABLE: chrome, satin gold, satin black nickel

GLASS COLOUR AVAILABLE: transparent (01), pink (03), amber (05), green (06), sky-blue (07), fume (08), tobacco (16), ruby (17)

ERHAELTICHE AUSFÜHRUNGEN DER METALLTEILE: Chrom, Gold satiniert, schwarzes Nickel satiniert

ERHAELTICHE GLASFARBEN: transparent (01), rosa (03), bernstein (05), grün (06), hellblau (07), rauchfarben (08), tabak (16), rubinrot (17)

TABLE LAMP (on demand: with dimmer push button)

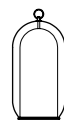

CODE	TRANSPARENT	COLOURED	COLOURED FUME (08)
LU1530	€ 433,00	€ 510,00	€ 510,00
LUGIG1530	€ 815,00	€ 978,00	€ 1.076,00
LUXXL1530	€ 1.092,00	€ 1.309,00	€ 1.440,00

SINGLE PENDANT with canopy

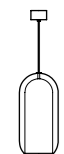

CODE	TRANSPARENT	COLOURED	COLOURED FUME (08)
1533.1L	€ 298,00	€ 357,00	€ 357,00
MED1533.1L	€ 380,00	€ 455,00	€ 455,00
GIG1533.1L	€ 617,00	€ 740,00	€ 812,00
XXL1533.1L	€ 919,00	€ 1.102,00	€ 1.210,00

* CODE without canopy for compositions

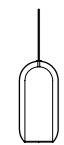

CODE	TRANSPARENT	COLOURED	COLOURED FUME (08)
1533	€ 274,00	€ 333,00	€ 333,00
MED1533	€ 356,00	€ 431,00	€ 431,00
GIG1533	€ 593,00	€ 716,00	€ 788,00
XXL1533	€ 895,00	€ 1.078,00	€ 1.186,00

Composition example: TRACK STAINLESS POLISHED STEEL



CODE	TRANSPARENT	COLOURED	COLOURED FUME (08)
1537.120.3L	€ 1.075,00	€ 1.252,00	€ 1.252,00

Composition example: PLATE STAINLESS POLISHED STEEL

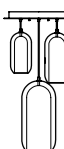

CODE	TRANSPARENT	COLOURED	COLOURED FUME (08)
1539MX.43.3L	€ 1.501,00	€ 1.758,00	€ 1.830,00



* TO CREATE **CUSTOM COMPOSITIONS**, USE THE PRICES **WITHOUT CANOPY** AND SELECT THE DESIRED STRUCTURE FROM PAGE 89 TO PAGE 105

- **STRUCTURE AND SMALL SINGLE CANOPY AVAILABLE IN:** Satin gold, Satin black nickel - without surcharge
 FASSUNG UND EINZELBALDACHINE ERHAELTLICH IN: Gold satiniert, Schwarzes nickel satiniert - ohne aufpreis

- **TRACKS AND PLATES AVAILABLE ONLY IN:** Chrome, Matt white, Matt black, Brushed chrome
 SCHIENEN UND DECKENPLATTEN NUR ERHAELTLICH IN: Chrom, Weiss matt, Schwarz matt, Chrom gebürstet

- **BLACK RUBBER ELECTRIC CABLE**
 SCHWARZES KABEL AUS GUMMI

- **STRUCTURE IN GALVANIZED BRASS**
 GALVANISIERTE MESSINGSTRUKTUR

- **ONLY ON PRODUCTS GIG AND XXL IN FUME (08) COLOUR: 10% SURCHARGE ON THE PRICE OF THE COLOURED**
 NUR FUER ARTIKEL GIG UND XXL IN FARBE RAUCHFARBEN (08): +10% AUFPREIS AUF "COLOURED" PREISE

- **ON DEMAND: WITH UL COMPONENTS +10% in addition**
 AUF ANFRANGE: MIT UL KOMPONENTEN + 10% Aufpreis

Description	Bulb (not included)	Cable	Net weight kg	Gross weight kg	Package cm
Table lamp Ø13 - H29 cm	E14 1 x max 40W	200 cm	1,210	2,150	26 x 26 x 47
Table lamp Ø21 - H49 cm	E27 1 x max 60W	200 cm	4,000	5,300	29 x 29 x 57
Table lamp Ø28 - H56 cm	E27 1 x max 60W	200 cm	5,670	6,700	39 x 39 x 67

Description	Bulb (not included)	Cable	Net weight kg	Gross weight kg	Package cm
Single pendant, glass Ø13 H28 cm - FOL9 canopy	E14 1 x max 42W	150 cm	0,860	1,900	26 x 26 x 47
Single pendant, glass Ø15 H34 cm - FOL9 canopy	E27 1 x max 70W	150 cm	1,356	2,400	26 x 26 x 47
Single pendant, glass Ø21 H48 cm - FOL9 canopy	E27 1 x max 70W	150 cm	2,800	3,900	29 x 29 x 57
Single pendant, glass Ø28 H55 cm - FOL9 canopy	E27 1 x max 70W	150 cm	3,570	4,700	39 x 39 x 67

Description	Bulb (not included)	Cable	Net weight kg	Gross weight kg	Package cm
Single pendant without canopy, glass Ø13 H28 cm	E14 1 x max 42W	150 cm	0,660	1,800	26 x 26 x 47
Single pendant without canopy, glass Ø15 H34 cm	E27 1 x max 70W	150 cm	1,156	2,300	26 x 26 x 47
Single pendant without canopy, glass Ø21 H48 cm	E27 1 x max 70W	150 cm	2,600	3,800	29 x 29 x 57
Single pendant without canopy, glass Ø28 H55 cm	E27 1 x max 70W	150 cm	3,370	4,600	39 x 39 x 67

Description	Bulb (not included)	Cable	Net weight kg	Gross weight kg	Package cm
Track AUF120 L120 cm, 3x glass Ø13 H28 cm	E14 3 x max 42W	150 cm	3,700	8,500	10 x 10 x 162 / 3X 26 x 26 x 47

Description	Bulb (not included)	Cable	Net weight kg	Gross weight kg	Package cm
Plate P43 Ø43 cm, glass Ø13-15-21 cm	E14 1x max 42W E27 2x max 70W	150 cm	6,830	10,200	51 x 51 x 14 2X 26 x 26 x 47 / 29 x 29 x 57

METAL STRUCTURE AVAILABLE: black carbon, champagne, french gold

GLASS COLOUR AVAILABLE: transparent (01), pink (03), amber (05), green (06), sky-blue (07), fume (08), tobacco (16), ruby (17)

ERHAELTICHE AUSFÜHRUNGEN DER METALLTEILE: black carbon, champagne, french gold

ERHAELTICHE GLASFARBEN: transparent (01), rosa (03), bernstein (05), grün (06), hellblau (07), rauchfarben (08), tabak (16), rubinrot (17)

ON DEMAND:
AUF ANFRAGE:

WITH UL COMPONENTS
+10% in addition

MIT UL KOMPONENTEN
+ 10% Aufpreis

AVAILABLE WITH DALI
(ask for a quote)

ERHÄLTICH MIT DALI
(Angebot erfragen)

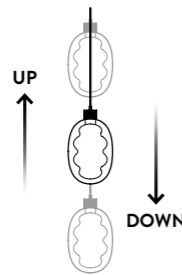

AVAILABLE WITH UP & DOWN SYSTEM (see price on page 105)

- AVAILABLE ONLY FOR DALMA® 1613 and GIG1613 (maximum weight 1,8 kg)
- CABLE AVAILABLE IN BLACK diam. 2,1 mm
- COAXIAL CABLE 0,24M2
- ADJUSTMENT: minimum length ca. 0,55 m / maximum length 1,90 m

ERHÄLTICH MIT UP&DOWN SYSTEM (siehe Preise Seite 105)

- NUR FUER DALMA® 1613 and GIG1613(max. Gewicht 1,8 kg)
- KABEL ERHAELTICH IN SCHWARZ Durchm. 2,1 mm
- KOAXIALKABEL SCHWARZ 0,24M2
- HOEHENVERSTELLUNG: Mindestlaenge ca. 0,55 m – Max. Laenge 1,90 m



FLOOR LAMP

CODE	TRANSPARENT	COLOURED nuanced	
LU1615.1L	€ 1.100,00	€ 1.265,00	
LUGIG1615.1L	€ 1.330,00	€ 1.530,00	

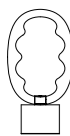

TABLE LAMP

CODE	TRANSPARENT	COLOURED nuanced	
LU1610.1L	€ 724,00	€ 833,00	
LUGIG1610.1L	€ 915,00	€ 1.051,00	



TABLE LAMP with stand

CODE	TRANSPARENT	COLOURED nuanced	
LU1614.1L	€ 990,00	€ 1.125,00	



* TO CREATE **CUSTOM COMPOSITIONS**, USE THE PRICES **WITHOUT CANOPY**
AND SELECT THE DESIRED STRUCTURE FROM PAGE 89 TO PAGE 105

- **COAXIAL LOW VOLTAGE ELECTRIC CABLE IN TRANSPARENT OR BLACK**
NIEDERVOLT KOAXIALKABEL IN TRANSPARENT ODER SCHWARZ

- **GLASS WITH COLOURED NUANCED**
GLAS MIT FARBIGEN NUANCED

- **STRUCTURE AVAILABLE IN: black carbon, champagne, french gold**
RAHMEN ERHAELTICH IN: black carbon, champagne, french gold

- **TRACKS AND PLATES AVAILABLE ONLY IN: black carbon, champagne, french gold**
SCHIENEN UND DECKENPLATTEN NUR ERHAELTICH IN: black carbon, champagne, french gold

- **ALUMINUM LAMP HOLDER**
FASSUNG AUS ALUMINIUM

- **COMPATIBLE WITH CASAMBI**
KOMPATIBEL MIT

- **DRIVER INCLUDED**
TRAFO INBEGRIFFEN

- **DIMMABLE: YES (PHASE-CUT DIMMER TRIAC) - LED IS REPLACEABLE BY PROFESSIONAL**
DIMMBAR: (PHASENABSCHNITT) LED-PLATINE VON FACHMANN AUSTAUSCHBAR

LEDS AVAILABLE FOR DALMA® / ERHAELTICHE LEDS FUER DALMA®SERIE:

LED 1 x 9W Dimmer Triac - 27 V - 350 mA - CRI Typ 95 - 1125 Lm - 125 Lm/W - 3 Step MacAdam - **2700°K**
LED 1 x 9W Dimmer Triac - 27 V - 350 mA - CRI Typ 95 - 1125 Lm - 125 Lm/W - 3 Step MacAdam - **3000°K**

LED AVAILABLE FOR DALMA® GIG / ERHAELTICHE LEDS FUER DALMA® GIG SERIE:

LED 1 x 12W Dimmer Triac - 36 V - 350 mA - CRI Typ 95 - 1500 Lm - 125 Lm/W - 3 Step MacAdam - **2700°K**
LED 1 x 12W Dimmer Triac - 36 V - 350 mA - CRI Typ 95 - 1500 Lm - 125 Lm/W - 3 Step MacAdam - **3000°K**

LUMEN INDICATED CORRESPONDS TO THE LUMINOUS INTENSITY AT THE ORIGIN OF THE LED BOARD
DIE ANGEGBENEN LUMEN ENTSPRECHEN DER LICHTINTENSITAET DER URSPRUENGLICHEN LED-PLATINE

Description	LED (driver included)	Cable	Net weight kg	Gross weight kg	Package cm
Floor lamp Ø17 - H 174 cm with dimmer push button	LED 1 x 9W DIMM	200 cm	7,700	10,700	26 x 26 x 47 / 29 x 29 x 181
Floor lamp Ø24 - H 185 cm with dimmer push button	LED 1 x 12W DIMM	200 cm	8,400	11,400	29 x 29 x 57 / 29 x 29 x 181

Description	LED (driver included)	Cable	Net weight kg	Gross weight kg	Package cm
Table lamp Ø17 - H 33 cm with dimmer push button	LED 1 x 9W DIMM	200 cm	2,250	3,250	26 x 26 x 47
Table lamp Ø24 - H 43 with dimmer push button	LED 1 x 12W DIMM	200 cm	3,000	5,200	29 x 29 x 57

Description	LED (driver included)	Cable	Net weight kg	Gross weight kg	Package cm
Table lamp Ø17 - H 70 cm with dimmer push button	LED 1 x 9W DIMM	200 cm	6,100	9,100	26 x 26 x 47 / 29 x 29 x 57

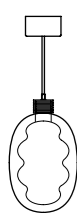

SINGLE PENDANT with canopy

CODE	TRANSPARENT	COLOURED nuanced	
1613.1L	€ 690,00	€ 714,00	
GIG1613.1L	€ 894,00	€ 1.028,00	

* CODE without canopy for compositions

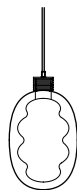

CODE	TRANSPARENT	COLOURED nuanced	
1613	€ 666,00	€ 690,00	
GIG1613	€ 870,00	€ 1.004,00	

Composition example: TRACK STAINLESS POLISHED STEEL

CODE	TRANSPARENT	COLOURED nuanced	
1617.120.3L	€ 2.251,00	€ 2.323,00	

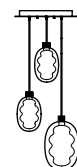
Composition example: PLATE STAINLESS POLISHED STEEL

CODE	TRANSPARENT	COLOURED nuanced	
1619MX.43.3L	€ 2.480,00	€ 2.662,00	

Description	LED (driver included)	Cable	Net weight kg	Gross weight kg	Package cm
Single pendant, glass Ø17 cm - FOL9 canopy	LED 1 x 9W DIMM	200 cm	1,100	2,100	26 x 26 x 47
Single pendant, glass Ø24 cm - FOL9 canopy	LED 1 x 12W DIMM	200 cm	1,800	3,000	29 x 29 x 57

Description	LED (driver included)	Cable	Net weight kg	Gross weight kg	Package cm
Single pendant without canopy, glass Ø17 cm H 25	LED 1 x 9W DIMM	200 cm	0,900	1,900	26 x 26 x 47
Single pendant without canopy, glass Ø24 cm H 35	LED 1 x 12W DIMM	200 cm	1,600	2,800	29 x 29 x 57

Description	LED (driver included)	Cable	Net weight kg	Gross weight kg	Package cm
Track AUF120 L120 cm, 3x glass Ø17 cm	LED 3 x 9W DIMM	200 cm	5,600	7,100	10 x 10 x 162 3X 26 x 26 x 47

Description	LED (driver included)	Cable	Net weight kg	Gross weight kg	Package cm
Plate P43 Ø43 cm, 2 x glass Ø17 cm, 1 x glass Ø24 cm	LED 2 x 9W DIMM LED 1 x 12W DIMM	200 cm	5,800	7,300	51 x 51 x 14 / 26 x 26 x 47 / 26 x 26 x 47 / 29 x 29 x 57

METAL STRUCTURE AVAILABLE: chrome

GLASS COLOUR AVAILABLE: transparent (01), pink (03), amber (05), green (06), sky-blue (07), fume (08), tobacco (16), ruby (17)

METALLIC GLASS COLOUR AVAILABLE only for diam. 14 cm: steel, bronze, black, gold, rose gold

ERHAELTICHE AUSFÜHRUNGEN DER METALLTEILE: Chrom

ERHAELTICHE GLASFARBEN: transparent (01), rosa (03), bernstein (05), grün (06), hellblau (07), rauchfarben (08), tabak (16), rubinrot (17)

ERHAELTICHE METALLISCHE GLASFARBEN (nur fuer Durchm. 14cm): Stahl, Bronze, Schwarz, Gold, Roségold

TABLE LAMP



CODE	TRANSPARENT	COLOURED	COLOURED FUME (08)	METALLIC GLASS
S1290.1L	€ 227,00	€ 268,00	€ 268,00	€ 316,00

WALL LAMP/CEILING LAMP



CODE	TRANSPARENT	COLOURED	COLOURED FUME (08)	METALLIC GLASS
APS1291.1L	€ 206,00	€ 237,00	€ 237,00	€ 294,00

SINGLE PENDANT with canopy

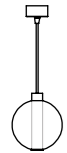

CODE	TRANSPARENT	COLOURED	COLOURED FUME (08)	METALLIC GLASS
1293.1L	€ 206,00	€ 237,00	€ 237,00	€ 294,00
MED1293.1L	€ 259,00	€ 340,00	€ 340,00	not available
GIG1293.1L	€ 280,00	€ 370,00	€ 405,00	not available
XXL1293.1L	€ 319,00	€ 390,00	€ 427,00	not available

* **CODE without canopy** for compositions

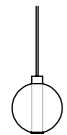

CODE	TRANSPARENT	COLOURED	COLOURED FUME (08)	METALLIC GLASS
1293	€ 182,00	€ 213,00	€ 213,00	€ 270,00
MED1293	€ 235,00	€ 316,00	€ 316,00	not available
GIG1293	€ 256,00	€ 346,00	€ 381,00	not available
XXL1293	€ 295,00	€ 366,00	€ 403,00	not available

Composition example: PLATE STAINLESS POLISHED STEEL

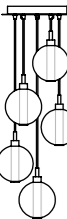

CODE	TRANSPARENT	COLOURED	COLOURED FUME (08)	METALLIC GLASS
1299.3L	€ 764,00	€ 857,00	€ 857,00	€ 1.028,00
1299.5L	€ 1.128,00	€ 1.283,00	€ 1.283,00	€ 1.568,00
1299.7L	€ 1.552,00	€ 1.769,00	€ 1.769,00	€ 2.168,00
1299.9L	€ 1.916,00	€ 2.195,00	€ 2.195,00	€ 2.708,00
1299.11L	€ 2.280,00	€ 2.621,00	€ 2.621,00	€ 3.248,00

Composition example: PLATE STAINLESS POLISHED STEEL



CODE	TRANSPARENT	COLOURED	COLOURED FUME (08)	METALLIC GLASS
1292.3L	€ 764,00	€ 857,00	€ 857,00	€ 1.028,00
1292.7L	€ 1.492,00	€ 1.709,00	€ 1.709,00	€ 2.108,00
1292.19L	€ 3.964,00	€ 4.553,00	€ 4.553,00	€ 5.636,00
1292.37L	€ 7.559,00	€ 8.706,00	€ 8.706,00	€ 10.815,00



* TO CREATE **CUSTOM COMPOSITIONS**, USE THE PRICES **WITHOUT CANOPY** AND SELECT THE DESIRED STRUCTURE FROM PAGE 89 TO PAGE 105

- **TRANSPARENT ELECTRIC CABLE**, on demand: brown / red, without surcharge
TRANSPARENTES KABEL (auf anfrage: braun / rot, ohne aufpreis)

- **ONLY ON PRODUCTS GIG AND XXL IN FUME (08) COLOUR: 10% SURCHARGE ON THE PRICE OF THE COLOURED**
NUR FUER ARTIKEL GIG UND XXL IN FARBE RAUCHFARBEN (08): +10% AUFPREIS AUF "COLOURED" PREISE

- **ON DEMAND: WITH UL COMPONENTS +10% in addition**
AUF ANFRAGE: MIT UL KOMPONENTEN + 10% Aufpreis

Description	Bulb (not included)	Cable	Net weight kg	Gross weight kg	Package cm
Table lamp Ø15 - H20 cm	G9 1 x max 33W	200 cm	0,835	1,500	38 x 18 x 19

Description	Bulb (not included)	Cable	Net weight kg	Gross weight kg	Package cm
Wall/Ceiling lamp Ø14 P17 H14 cm	G9 1 x max 33W	/	0,510	1,200	38 x 18 x 19

Description	Bulb (not included)	Cable	Net weight kg	Gross weight kg	Package cm
Single pendant, glass Ø14 H16 cm - ECL6 canopy	G9 1 x max 33W	150 cm	0,510	1,200	38 x 18 x 19
Single pendant, glass Ø22 H24 cm - AUF7,5 canopy	G9 1 x max 33W	150 cm	0,855	1,580	29 x 29 x 47
Single pendant, glass Ø24 H26 cm - AUF7,5 canopy	G9 1 x max 33W	150 cm	0,925	2,025	29 x 29 x 57
Single pendant, glass Ø26 H28 cm - AUF7,5 canopy	G9 1 x max 33W	150 cm	1,000	2,100	41 x 41 x 42

Description	Bulb (not included)	Cable	Net weight kg	Gross weight kg	Package cm
Single pendant without canopy, glass Ø14 H16 cm	G9 1 x max 33W	150 cm	0,510	1,200	38 x 18 x 19
Single pendant without canopy, glass Ø22 H24 cm	G9 1 x max 33W	150 cm	0,650	1,375	33 x 33 x 34
Single pendant without canopy, glass Ø24 H26 cm	G9 1 x max 33W	150 cm	0,715	1,850	41 x 41 x 32
Single pendant without canopy, glass Ø26 H28 cm	G9 1 x max 33W	150 cm	0,800	1,900	41 x 41 x 32

Description	Bulb (not included)	Cable	Net weight kg	Gross weight kg	Package cm
Plate P27 Ø27 cm, 3x glass Ø14 H16 cm	G9 3 x max 33W	150 cm	2,200	3,200	33 x 33 x 24 / 61 x 26 x 29
Plate P27 Ø27 cm, 5x glass Ø14 H16 cm	G9 5 x max 33W	150 cm	2,700	4,000	33 x 33 x 24 / 41 x 41 x 42
Plate P43 Ø43 cm, 7x glass Ø14 H16 cm	G9 7 x max 33W	150 cm	4,900	7,000	51 x 51 x 14 / 41 x 41 x 42
Plate P43 Ø43 cm, 9x glass Ø14 H16 cm	G9 9 x max 33W	150 cm	5,600	8,000	51 x 51 x 14 / 43 x 43 x 54
Plate P43 Ø43 cm, 11x glass Ø14 H16 cm	G9 11 x max 33W	150 cm	6,300	8,600	51 x 51 x 14 / 43 x 43 x 64

Description	Bulb (not included)	Cable	Net weight kg	Gross weight kg	Package cm
Cluster Ø28 cm, plate Ø27 cm, 3x glass Ø14 H16 cm	G9 3 x max 33W	150 cm	2,250	3,700	33 x 33 x 24 / 61 x 26 x 29
Cluster Ø43 cm, plate Ø27 cm, 7x glass Ø14 H16 cm	G9 7 x max 33W	150 cm	4,000	6,000	33 x 33 x 24 / 41 x 41 x 42
Cluster Ø72 cm, plate Ø43 cm, 19x glass Ø14 H16 cm	G9 19 x max 33W	250 cm	9,500	14,000	51 x 51 x 14 / 51 x 51 x 60
Cluster Ø100 cm, plate Ø50 cm, 37x glass Ø14 H16 cm	G9 37 x max 33W	250 cm	18,200	25,000	51 x 51 x 14 / 2X 51 x 51 x 60

ECLISSE MAX[®]

METAL STRUCTURE AVAILABLE: chrome, brushed chrome, matt white, matt black

GLASS COLOUR AVAILABLE: transparent (01), pink (03), amber (05), green (06), sky-blue (07), fume (08), tobacco (16), ruby (17)

METALLIC GLASS COLOUR AVAILABLE: steel, bronze, black

ERHAELTICHE AUSFÜHRUNGEN DER METALLTEILE: Chrom, Chrom gebürstet, Weiss matt, Schwarz Matt

ERHAELTICHE GLASFARBEN: transparent (01), rosa (03), bernstein (05), grün (06), hellblau (07), rauchfarben (08), tabak (16), rubinrot (17)

ERHAELTICHE METALLISCHE GLASFARBEN: Stahl, Bronze, Schwarz

ON DEMAND:
AUF ANFRAGE:

WITH UL COMPONENTS
+10% in addition

MIT UL KOMPONENTEN
+ 10% Aufpreis

AVAILABLE WITH DALI
(ask for a quote)

ERHÄLTICH MIT DALI
(Angebot erfragen)

COMPATIBLE WITH
KOMPATIBEL MIT

CASAMBI

TABLE LAMP



CODE	TRANSPARENT	COLOURED	COLOURED FUME (08)	METALLIC GLASS
LU1560.1L	€ 311,00	€ 396,00	€ 396,00	€ 428,00

WALL LAMP/CEILING LAMP



CODE	TRANSPARENT	COLOURED	COLOURED FUME (08)	METALLIC GLASS
API561.1L	€ 270,00	€ 356,00	€ 356,00	€ 388,00

SINGLE PENDANT with canopy

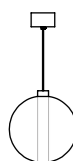

CODE	TRANSPARENT	COLOURED	COLOURED FUME (08)	METALLIC GLASS
1563.1L	€ 274,00	€ 359,00	€ 359,00	€ 391,00
GIG1563.1L	€ 295,00	€ 391,00	€ 428,00	€ 423,00
XXL1563.1L	€ 338,00	€ 413,00	€ 452,00	€ 445,00

* **CODE without canopy** for compositions



CODE	TRANSPARENT	COLOURED	COLOURED FUME (08)	METALLIC GLASS
1563	€ 250,00	€ 335,00	€ 335,00	€ 367,00
GIG1563	€ 271,00	€ 367,00	€ 404,00	€ 399,00
XXL1563	€ 314,00	€ 389,00	€ 428,00	€ 421,00

Composition example: **PLATE** STAINLESS POLISHED STEEL

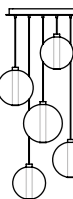

CODE	TRANSPARENT	COLOURED	COLOURED FUME (08)	METALLIC GLASS
1569MX.43.3L	€ 1.113,00	€ 1.369,00	€ 1.445,00	€ 1.465,00
1569MX.50.5L	€ 1.737,00	€ 2.174,00	€ 2.287,00	€ 2.334,00

Composition example: **TRACK** STAINLESS POLISHED STEEL



CODE	TRANSPARENT	COLOURED	COLOURED FUME (08)	METALLIC GLASS
1567.120.3L	€ 1.003,00	€ 1.258,00	€ 1.258,00	€ 1.354,00

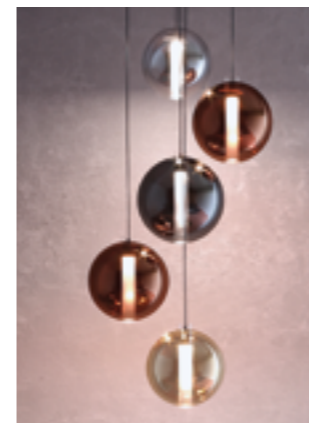

* TO CREATE **CUSTOM COMPOSITIONS**, USE THE PRICES **WITHOUT CANOPY**
AND SELECT THE DESIRED STRUCTURE FROM PAGE 89 TO PAGE 105

- **COAXIAL LOW VOLTAGE ELECTRIC CABLE IN TRANSPARENT OR BLACK**
NIEDERVOLT KOAXIALKABEL IN TRANSPARENT ODER SCHWARZ

- **SMALL SINGLE CANOPY AVAILABLE IN: Satin gold, Satin rose gold, Satin black nickel - without surcharge**
BALDACHIN FUER EINZELPENDEL ERHAELTICH IN: Satin gold, Satin roségold, Satin schwarz nickel - ohne aufpreis

- **TRACKS AND PLATES AVAILABLE ONLY IN: Chrome, Matt white, Matt black, Brushed chrome**
SCHIENEN UND DECKENPLATTEN NUR ERHAELTICH IN: Chrom, Weiss matt, Schwarz matt, Chrom gebürstet

- **ALUMINIUM LAMP HOLDER**
FASSUNG AUS ALUMINIUM

- **ONLY ON PRODUCTS GIG AND XXL IN FUME (08) COLOUR: 10% SURCHARGE ON THE PRICE OF THE COLOURED**
NUR FUER ARTIKEL GIG UND XXL IN FARBE RAUCHFARBEN (08): +10% AUFPREIS AUF "COLOURED" PREISE

- **DRIVER INCLUDED**
TRAFO INBEGRIFFEN

- **DIMMABLE: YES (PHASE-CUT DIMMER TRIAC) - LED IS REPLACEABLE BY PROFESSIONAL**
DIMMBAR: (PHASENABSCHNITT) LED-PLATINE VON FACHMANN AUSTAUSCHBAR

LEDS AVAILABLE FOR ECLISSE MAX[®] / LERHAELTICHE LEDS FUER ECLISSE MAX[®] SERIE:

LED 1 x 6W Dimmer Triac - 11,2-12,8 V - 500 mA - CRI Typ 95 - 866 Lm - 144 Lm/W - 3 Step MacAdam - **2700°K**
LED 1 x 6W Dimmer Triac - 11,2-12,8 V - 500 mA - CRI Typ 95 - 866 Lm - 144 Lm/W - 3 Step MacAdam - **3000°K**

LUMEN INDICATED CORRESPONDS TO THE LUMINOUS INTENSITY AT THE ORIGIN OF THE LED BOARD
DIE ANGEGBENEN LUMEN ENTSPRECHEN DER LICHTINTENSITAET DER URSPRÜNGLICHEN LED-PLATINE

Description	LED (driver included)	Cable	Net weight kg	Gross weight kg	Package cm
Table lamp Ø22 - H27 cm	LED 1 x 6W DIMM	200 cm	1,200	2,200	26 x 26 x 47

Description	LED (driver included)	Cable	Net weight kg	Gross weight kg	Package cm
Wall/Ceiling lamp Ø22 P27 H22 cm	LED 1 x 6W DIMM	/	1,090	1,815	26 x 26 x 47

Description	LED (driver included)	Cable	Net weight kg	Gross weight kg	Package cm
Single pendant, glass Ø22 H24 cm - PT9 canopy	LED 1 x 6W DIMM	200 cm	0,855	1,580	29 x 29 x 47
Single pendant, glass Ø24 H26 cm - PT9 canopy	LED 1 x 6W DIMM	200 cm	0,925	2,025	29 x 29 x 57
Single pendant, glass Ø26 H28 cm - PT9 canopy	LED 1 x 6W DIMM	200 cm	1,000	2,100	41 x 41 x 42

Description	LED (driver included)	Cable	Net weight kg	Gross weight kg	Package cm
Single pendant without canopy, glass Ø22 H24 cm	LED 1 x 6W DIMM	200 cm	0,650	1,375	29 x 29 x 47
Single pendant without canopy, glass Ø24 H26 cm	LED 1 x 6W DIMM	200 cm	0,715	1,850	29 x 29 x 57
Single pendant without canopy, glass Ø26 H28 cm	LED 1 x 6W DIMM	200 cm	0,800	1,900	41 x 41 x 42

Description	LED (driver included)	Cable	Net weight kg	Gross weight kg	Package cm
Plate P43 Ø43 cm, glass Ø22-24-26 cm	LED 3 x 6W DIMM	200 cm	4,635	5,825	51 x 51 x 14 / 29 x 29 x 47 29 x 29 x 57 / 41 x 41 x 42
Plate P50 Ø50 cm, glass 2x Ø22 - 2x Ø24 - 1x Ø26 cm	LED 5 x 6W DIMM	200 cm	8,555	9,890	51 x 51 x 14 / 41 x 41 x 42 2X 29 x 29 x 47 / 2X 29 x 29 x 57

Description	LED (driver included)	Cable	Net weight kg	Gross weight kg	Package cm
Track AUF120 L120 cm, 3x glass Ø22 H24 cm	LED 3 x 6W DIMM	200 cm	3,400	6,165	10 x 10 x 162 / 3X 29 x 29 x 47

FIJI © ® ®

EUIPO's registered community design

METAL STRUCTURE AVAILABLE: chrome, matt black**GLASS COLOUR AVAILABLE:** transparent (01), pink (03), amber (05), green (06), sky-blue (07), fume (08), tobacco (16), ruby (17), matt black**GLASS DIFFUSER IN SANDED GLASS****ERHAELTICHE AUSFÜHRUNGEN DER METALLTEILE:** Chrom, Schwarz Matt**ERHAELTICHE GLASFARBEN:** transparent (01), rosa (03), bernstein (05), grün (06), hellblau (07), rauchfarben (08), tabak (16), rubinrot (17), Schwarz Matt**LICHTDIFFUSOR AUS SANDGESTRAHLEM GLAS**

* TO CREATE **CUSTOM COMPOSITIONS**, USE THE PRICES **WITHOUT CANOPY**
AND SELECT THE DESIRED STRUCTURE FROM PAGE 89 TO PAGE 105

- BLACK RUBBER ELECTRIC CABLE

SCHWARZES KABEL AUS GUMMI

- ALUMINUM LAMP HOLDER

FASSUNG AUS ALUMINIUM

- ONLY ON PRODUCTS GIG AND XXL IN FUME (08) COLOUR: 10% SURCHARGE ON THE PRICE OF THE COLOURED
NUR FUER ARTIKEL GIG UND XXL IN FARBE RAUCHFARBEN (08): +10% AUFPREIS AUF "COLOURED" PREISE

- COMPATIBLE WITH

KOMPATIBEL MIT

CASAMBI**- DRIVER INCLUDED**

TRAFO INBEGRIFFEN

- DIMMABLE: YES (PHASE-CUT DIMMER TRIAC) - LED IS REPLACEABLE BY PROFESSIONAL
DIMMBAR: (PHASENABSCHNITT) LED-PLATINE VON FACHMANN AUSTAUSCHBAR

LEDs AVAILABLE FOR FIJI® / LERHAELTICHE LEDS FUER FIJI® SERIE:

LED 1 x 12,8W Dimmer Triac - 32-40V - 350mA - CRI Typ 95 - 1615 Lm - 126 Lm/W - IP20 - 180° - 3 Step MacAdam - **2700°K**LED 1 x 12,8W Dimmer Triac - 32-40V - 350mA - CRI Typ 95 - 1615 Lm - 126 Lm/W - IP20 - 180° - 3 Step MacAdam - **3000°K**

LUMEN INDICATED CORRESPONDS TO THE LUMINOUS INTENSITY AT THE ORIGIN OF THE LED BOARD
DIE ANGEGBENEN LUMEN ENTSPRECHEN DER LICHTINTENSITAET DER URSPRÜNGLICHEN LED-PLATINE

ON DEMAND:
AUF ANFRAGE:

WITH UL COMPONENTS
+10% in addition

MIT UL KOMPONENTEN
+ 10% Aufpreis

AVAILABLE WITH DALI
(ask for a quote)

ERHÄLTICH MIT DALI
(Angebot erfragen)

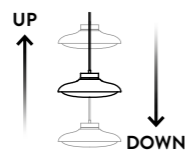
**AVAILABLE WITH UP & DOWN SYSTEM (see price on page 105)**

- AVAILABLE ONLY FOR FIJI® 1483 GIG1483 (maximum weight 1,8 kg)
- CABLE AVAILABLE IN BLACK diam. 2,1 mm
- COAXIAL CABLE 0,24M2
- ADJUSTMENT: minimum length ca. 0,55 m / maximum length 1,90 m

ERHÄLTICH MIT UP&DOWN SYSTEM (siehe Preise Seite 105)

- NUR FUER FIJI® 1483 GIG1483 ERHAELTICH (max. Gewicht 1,8 kg)
- KABEL ERHAELTICH IN SCHWARZ Durchm. 2,1 mm
- KOAXIALKABEL SCHWARZ 0,24M2
- HOEHENVERSTELLUNG: Mindestlaenge ca. 0,55 m - Max. Laenge 1,90 m

WALL LAMP



CODICE	SATIN GLASS		
AP1481.1L	€ 320,00		
APGIG1481.1L	€ 392,00		
APXXL1481.1L	€ 821,00		

Description	LED (driver included)		Net weight kg	Gross weight kg	Package cm
Wall lamp Ø26 P13 H26 cm (only satin diffuser)	LED 1 x 12,8W	/	0,820	1,770	33 x 33 x 34
Wall lamp Ø34 P16 H34 cm (only satin diffuser)	LED 1 x 12,8W	/	1,060	2,260	41 x 41 x 42
Wall lamp Ø40 P17 H40 cm (only satin diffuser)	LED 1 x 12,8W	/	2,310	4,210	51 x 51 x 50

SINGLE PENDANT with canopy

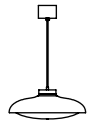

CODE	TRANSPARENT	COLOURED	COLOURED FUME (08)
1483.1L	€ 373,00	€ 443,00	€ 443,00
GIG1483.1L	€ 591,00	€ 639,00	€ 701,00
XXL1483.1L	€ 1.160,00	€ 1.229,00	€ 1.350,00

* CODE without canopy for compositions

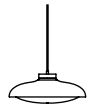

CODE	TRANSPARENT	COLOURED	COLOURED FUME (08)
1483	€ 349,00	€ 419,00	€ 419,00
GIG1483	€ 567,00	€ 615,00	€ 677,00
XXL1483	€ 1.136,00	€ 1.205,00	€ 1.326,00

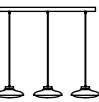
Composition example: TRACK STAINLESS POLISHED STEEL

CODE	TRANSPARENT	COLOURED	COLOURED FUME (08)
1487.120.3L	€ 1.300,00	€ 1.510,00	€ 1.510,00

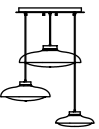
Composition example: PLATE STAINLESS POLISHED STEEL

CODE	TRANSPARENT	COLOURED	COLOURED FUME (08)
1489MX.50.3L	€ 2.433,00	€ 2.620,00	€ 2.803,00

Description	LED (driver included)	Cable	Net weight kg	Gross weight kg	Package cm
Single pendant, glass Ø28 H12 cm - FOL9 canopy	LED 1 x 12,8W	150 cm	1,240	2,190	33 x 33 x 34
Single pendant, glass Ø36 H15 cm - FOL9 canopy	LED 1 x 12,8W	150 cm	1,770	2,970	41 x 41 x 42
Single pendant, glass Ø46 H16 cm - FOL9 canopy	LED 1 x 12,8W	150 cm	3,820	5,720	51 x 51 x 50

Description	LED (driver included)	Cable	Net weight kg	Gross weight kg	Package cm
Single pendant without canopy, glass Ø28 H12 cm	LED 1 x 12,8W	150 cm	1,240	2,190	33 x 33 x 34
Single pendant without canopy, glass Ø36 H15 cm	LED 1 x 12,8W	150 cm	1,770	2,970	41 x 41 x 42
Single pendant without canopy, glass Ø46 H16 cm	LED 1 x 12,8W	150 cm	3,820	5,720	51 x 51 x 50

Description	LED (driver included)	Cable	Net weight kg	Gross weight kg	Package cm
Track AUF120 L120 cm, 3x glass Ø28 H12 cm	LED 3 x 12,8W	150 cm	4,790	8,945	10 x 10 x 162 / 3X 33 x 33 x 34

Description	LED (driver included)	Cable	Net weight kg	Net weight kg	Package cm
Plate P50 Ø50 cm, glass Ø28-36-46 cm	LED 3 x 12,8W	150 cm	11,830	17,080	51 x 51 x 14 / 33 x 33 x 34 41 x 41 x 42 / 51 x 51 x 50

VISIBLE METAL STRUCTURE AVAILABLE: chrome, brushed chrome, matt white, matt black

GLASS COLOUR AVAILABLE: transparent (01), pink (03), amber (05), green (06), sky-blue (07), fume (08), tobacco (16), ruby (17)

METALLIC GLASS COLOUR AVAILABLE: bronze, black, rose gold, titanium

ERHAETLICHE AUSFÜHRUNGEN DER METALLTEILE: Chrom, Chrom gebürstet, Weiss matt, Schwarz Matt

ERHAETLICHE GLASFARBEN: transparent (01), rosa (03), bernstein (05), grün (06), hellblau (07), rauchfarben (08), tabak (16), rubinrot (17)

ERHAETLICHE METALLISCHE GLASFARBEN: Bronze, Schwarz, Roségold, Titanium

TABLE LAMP



CODE	TRANSPARENT	COLOURED	COLOURED FUME (08)	BRONZE/BLACK	ROSE GOLD/TITANIUM
LU1390.1L	€ 348,00	€ 416,00	€ 416,00	€ 469,00	€ 501,00
LUGIG1390.1L	€ 528,00	€ 632,00	€ 696,00	€ 712,00	€ 761,00

WALL LAMP

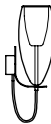

CODE	TRANSPARENT	COLOURED	COLOURED FUME (08)	BRONZE/BLACK	ROSE GOLD/TITANIUM
API391.1L	€ 334,00	€ 402,00	€ 402,00	€ 458,00	€ 489,00

SINGLE PENDANT with canopy



CODE	TRANSPARENT	COLOURED	COLOURED FUME (08)	BRONZE/BLACK	ROSE GOLD/TITANIUM
1393.1L	€ 305,00	€ 366,00	€ 366,00	€ 425,00	€ 452,00
GIG1393.1L	€ 457,00	€ 548,00	€ 601,00	€ 637,00	€ 679,00
XXL1393.1L	€ 662,00	€ 793,00	€ 870,00	€ 885,00	€ 943,00

*** CODE without canopy** for compositions



CODE	TRANSPARENT	COLOURED	COLOURED FUME (08)	BRONZE/BLACK	ROSE GOLD/TITANIUM
1393	€ 281,00	€ 342,00	€ 342,00	€ 401,00	€ 428,00
GIG1393	€ 433,00	€ 524,00	€ 577,00	€ 613,00	€ 655,00
XXL1393	€ 638,00	€ 769,00	€ 846,00	€ 861,00	€ 919,00

Composition example: MULTIPLE SUSPENSION LAMP



CODE	TRANSPARENT	COLOURED	COLOURED FUME (08)	BRONZE/BLACK	ROSE GOLD/TITANIUM
1393.2L	€ 638,00	€ 760,00	€ 760,00	€ 878,00	€ 932,00
1393.3L	€ 945,00	€ 1.128,00	€ 1.128,00	€ 1.305,00	€ 1.386,00
GIG1393.2L	€ 942,00	€ 1.124,00	€ 1.230,00	€ 1.302,00	€ 1.386,00
XXL1393.2L	€ 1.352,00	€ 1.614,00	€ 1.768,00	€ 1.798,00	€ 1.914,00

Composition example: PLATE STAINLESS POLISHED STEEL

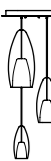

CODE	TRANSPARENT	COLOURED	COLOURED FUME (08)	BRONZE/BLACK	ROSE GOLD/TITANIUM
1399MX.43.3L	€ 1.630,00	€ 1.913,00	€ 2.043,00	€ 2.153,00	€ 2.280,00

Composition example: TRACK STAINLESS POLISHED STEEL



CODE	TRANSPARENT	COLOURED	COLOURED FUME (08)	BRONZE/BLACK	ROSE GOLD/TITANIUM
1397.90.3L	€ 1.060,00	€ 1.243,00	€ 1.243,00	€ 1.420,00	€ 1.501,00
GIG1397.120.3L	€ 1.552,00	€ 1.825,00	€ 1.984,00	€ 2.092,00	€ 2.218,00



* TO CREATE **CUSTOM COMPOSITIONS**, USE THE PRICES **WITHOUT CANOPY** AND SELECT THE DESIRED STRUCTURE FROM PAGE 89 TO PAGE 105

- **TRANSPARENT ELECTRIC CABLE, ON DEMAND: BLACK TEXTILE, without surcharge**
TRANSPARENTES KABEL, AUF ANFRAGE: SCHWARZES TEXTILKABEL, ohne aufpreis

- **METAL ROD TUBE, ON DEMAND: MATT WHITE OR MATT BLACK, with surcharge +32,00 €**
METALLSTANGE ROHR, AUF ANFRAGE: WEISS MATT OR SCHWARZ MATT, mit Aufschlag +32,00 €

- **ONLY ON PRODUCTS GIG AND XXL IN FUME (08) COLOUR: 10% SURCHARGE ON THE PRICE OF THE COLOURED**
NUR FUER ARTIKEL GIG UND XXL IN FARBE RAUCHFARBEN (08): +10% AUFPREIS AUF "COLOURED" PREISE

- **ON DEMAND: WITH UL COMPONENTS +10% in addition**
AUF ANFRAGE: MIT UL KOMPONENTEN + 10% Aufpreis

Description	Bulb (not included)	Cable	Net weight kg	Gross weight kg	Package cm
Table lamp Ø12 - H31 cm	E14 1 x max 60W	200 cm	0,980	1,700	26 x 26 x 47
Table lamp Ø16 - H39 cm	E27 1 x max 105W	200 cm	1,630	2,370	26 x 26 x 47

Description	Bulb (not included)	Cable	Net weight kg	Gross weight kg	Package cm
Wall lamp L12 - P16 - H38 cm	E14 1 x max 60W	50 cm	0,760	1,610	26 x 26 x 47

Description	Bulb (not included)	Cable	Net weight kg	Gross weight kg	Package cm
Single pendant, glass Ø12 H27 cm - FL6 canopy	E14 1 x max 60W	150 cm	0,630	1,480	55 x 21 x 19
Single pendant, glass Ø16 H35 cm - FL6 canopy	E27 1 x max 105W	150 cm	1,130	1,880	26 x 26 x 47
Single pendant, glass Ø20 H45 cm - FL6 canopy	E27 1 x max 105W	150 cm	1,790	2,830	29 x 29 x 57

Description	Bulb (not included)	Cable	Net weight kg	Gross weight kg	Package cm
Single pendant without canopy, glass Ø12 H27 cm	E14 1 x max 60W	150 cm	0,630	1,480	55 x 21 x 19
Single pendant without canopy, glass Ø16 H35 cm	E27 1 x max 105W	150 cm	1,130	1,880	26 x 26 x 47
Single pendant without canopy, glass Ø20 H45 cm	E27 1 x max 105W	150 cm	1,790	2,830	29 x 29 x 57

Description	Bulb (not included)	Cable	Net weight kg	Gross weight kg	Package cm
Susp. composed of 2 glasses Ø12 cm - FL7 canopy - 2x WS2	E14 2 x max 60W	250 cm	1,235	2,550	61 x 26 x 29
Susp. composed of 3 glasses Ø12 cm - FL7 canopy - 3x WS2	E14 3 x max 60W	250 cm	1,835	3,250	41 x 41 x 42
Susp. composed of 2 glasses Ø16 cm - FL7 canopy - 2x WS2	E27 2 x max 105W	250 cm	2,235	3,660	2X 26 x 26 x 47
Susp. composed of 2 glasses Ø20 cm - FL7 canopy - 2x WS2	E27 2 x max 105W	250 cm	3,555	5,560	2X 29 x 29 x 57

Description	Bulb (not included)	Cable	Net weight kg	Gross weight kg	Package cm
Plate P43 Ø43 cm, glass Ø12-16-20 cm	E14 1 x max 60W E27 2 x max 105W	150 cm	5,460	9,370	51 x 51 x 14 / 38 x 18 x 19 26 x 26 x 47 / 29 x 29 x 57

Description	Bulb (not included)	Cable	Net weight kg	Gross weight kg	Package cm
Track AUF90 L90 cm, 3x glass Ø12 H27 cm	E14 3 x max 60W	150 cm	2,770	5,760	10 x 10 x 162 / 41 x 41 x 42
Track AUF120 L120 cm, 3x glass Ø16 H35 cm	E27 3 x max 105W	150 cm	4,580	7,370	10 x 10 x 162 / 3X 26 x 26 x 47

METAL STRUCTURE AVAILABLE: chrome, matt black

GLASS COLOUR AVAILABLE: transparent (01), pink (03), amber (05), green (06), sky-blue (07), fume (08), tobacco (16), ruby (17)

LOWER PART IN SANDED GLASS

ERHAELTICHE AUSFÜHRUNGEN DER METALLTEILE: Chrom, Schwarz Matt

ERHAELTICHE GLASFARBEN: transparent (01), rosa (03), bernstein (05), grün (06), hellblau (07), rauchfarben (08), tabak (16), rubinrot (17)

UNTERSEITE GLAS SANDGESTRAHLT

ON DEMAND:
AUF ANFRAGE:

WITH UL COMPONENTS
+10% in addition

MIT UL KOMPONENTEN
+ 10% Aufpreis

AVAILABLE WITH DALI
(ask for a quote)

ERHÄLTICH MIT DALI
(Angebot erfragen)

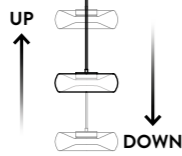

AVAILABLE WITH UP & DOWN SYSTEM (see price on page 105)

- AVAILABLE ONLY FOLD[©] 1513 GIG1513 (maximum weight 1,8 kg)
- CABLE AVAILABLE IN BLACK diam. 2,1 mm
- COAXIAL CABLE 0,24M2
- ADJUSTMENT: minimum length ca. 0,55 m / maximum length 1,90 m

ERHÄLTICH MIT UP&DOWN SYSTEM (siehe Preise Seite 105)

- NUR FUER FOLD[©] 1513 GIG1513 ERHAELTICH (max. Gewicht 1,8 kg)
- KABEL ERHAELTICH IN SCHWARZ Durchm. 2,1 mm
- KOAXIALKABEL SCHWARZ 0,24M2
- HOEHENVERSTELLUNG: Mindestlaenge ca. 0,55 m - Max. Laenge 1,90 m

FLOOR LAMP



CODE	TRANSPARENT	COLOURED	COLOURED FUME (08)
LUGIG1515.1L	€ 1.398,00	€ 1.526,00	€ 1.602,00

WALL LAMP



CODE	TRANSPARENT	COLOURED	COLOURED FUME (08)
AP1511.1L	€ 411,00	€ 453,00	€ 453,00
APGIG1511.1L	€ 673,00	€ 791,00	€ 867,00



* TO CREATE **CUSTOM COMPOSITIONS**, USE THE PRICES **WITHOUT CANOPY**
AND SELECT THE DESIRED STRUCTURE FROM PAGE 89 TO PAGE 105

- **BLACK RUBBER ELECTRIC CABLE**
SCHWARZES KABEL AUS GUMMI

- **ALUMINIUM LAMP HOLDER**
FASSUNG AUS ALUMINIUM

- **ONLY ON PRODUCTS GIG IN FUME (08) COLOUR: 10% SURCHARGE ON THE PRICE OF THE COLOURED**
NUR FUER ARTIKEL GIG IN FARBE RAUCHFARBEN (08): +10% AUFPREIS AUF "COLOURED" PREISE

- **COMPATIBLE WITH**
KOMPATIBEL MIT **CASAMBI**

- **DRIVER INCLUDED**
TRAFO INBEGRIFFEN

- **DIMMABLE: YES (PHASE-CUT DIMMER TRIAC) - LED IS REPLACEABLE BY PROFESSIONAL**
DIMMBAR: (PHASENABSCHNITT) LED-PLATINE VON FACHMANN AUSTAUSCHBAR

LEDS AVAILABLE FOR FOLD[©] / LERHAELTICHE LEDES FUER FOLD[©] SERIE:

FOR WALL LAMPS / Für Wandleuchten:

LED 12,8W Dimmer Triac - 1615 Lm - 126 Lm/W - IP20 - CC 350mA - CRI Typ.95 - 32-40V - 180° - **2700°K o/for 3000°K**

FOR SUSPENSION, TRACKS, FLOOR LAMP / Für Hängeleuchten Schienen Standleuchten:

LED 17,4W Dimmer Triac - 2370 Lm - 134,3 Lm/W - IP20 - CC 500mA - CRI Typ.95 - 32-40V - 180° - **2700°K o/for 3000°K**

LUMEN INDICATED CORRESPONDS TO THE LUMINOUS INTENSITY AT THE ORIGIN OF THE LED BOARD
DIE ANGEGBENEN LUMEN ENTSPRECHEN DER LICHTINTENSITAET DER URSPRÜNGLICHEN LED-PLATINE

Dear Customer,

The glass of the lamps created by Cangini e Tucci is made entirely following an artisanal process. The glass is heated over a flame and shaped by master glass blowers until the desired result is obtained.

The only way of creating the double concave shape of Fold is to model the glass using a hand tool – made of graphite – while the hot glass rotates around its longitudinal axis thanks to the use of a lathe. By gently placing this tool on the surface of the glass, the master glass blower is able to shape it as if it were a vase of clay. The striations that at times remain even on the finished glass product are testament to the authenticity of this manual process. These barely visible irregularities make each lamp unique, one of a kind, adding value to the item.

Every lamp that leaves Cangini e Tucci's lab is a piece of the artisanal history that has led to the popularity of the Made in Italy brand around the world. Therefore, we don't consider these kinds of details a reason to contest the quality of the product, instead they must be accepted as elements that valorise the manual production process that has always been a defining characteristic of Cangini e Tucci's products.

Sehr geehrter Kunde,

Das Glas für die Lampen von Cangini und Tucci wird ausschließlich in Handarbeit hergestellt. Das Glas wird mit einer Flamme erhitzt und vom Glasbläsermeister in die gewünschte Form gebracht.

Die einzige Möglichkeit, die doppelt konkave Form von Fold herzustellen, besteht darin, das Glas mit einem Handwerkzeug – Grafit – zu formen, während das erhitzte Glas auf einer Drehbank um seine Längsachse gedreht wird. Wenn der Glasbläsermeister dieses Werkzeug vorsichtig auf die Oberfläche des Glases setzt, kann er es wie eine Vase aus Ton formen. Zeugnis dieses handwerklichen Prozesses sind die Schlieren, die manchmal nach der Bearbeitung auf dem Glas zurückbleiben. Es sind diese kaum wahrnehmbaren Unregelmäßigkeiten, die jede Lampe zu einem Unikat machen und ihr einen Mehrwert verleihen.

Jede Lampe aus der Werkstatt von Cangini und Tucci ist ein Stück Handwerksgegeschichte, die das Made in Italy weltweit bekannt gemacht hat. Deshalb sind wir der Meinung, dass diese Art von Detail keine qualitative Herausforderung für das Produkt darstellt, sondern als ein Element zu betrachten ist, das den manuellen Herstellungsprozess aufwertet, der die Produkte von Cangini und Tucci seit jeher auszeichnet.

Description	LED (driver included)	Cable	Net weight kg	Gross weight kg	Package cm
Floor lamp Ø36 - H max 185 cm	LED 1 x 17,4W	200 cm	9,160	16,115	41 x 41 x 32 / 39 x 39 x 170

Description	LED (driver included)	Net weight kg	Gross weight kg	Package cm	
Wall lamp Ø24 P11 H24 cm	LED 1 x 12,8W	/	1,135	2,085	33 x 33 x 34
Wall lamp Ø36 P13 H36 cm	LED 1 x 12,8W	/	1,735	2,935	41 x 41 x 32

SINGLE PENDANT with canopy

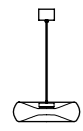

CODE	TRANSPARENT	COLOURED	COLOURED FUME (08)
1513.1L	€ 403,00	€ 447,00	€ 447,00
GIG1513.1L	€ 650,00	€ 778,00	€ 854,00

* CODE without canopy for compositions



CODE	TRANSPARENT	COLOURED	COLOURED FUME (08)
1513	€ 379,00	€ 423,00	€ 423,00
GIG1513	€ 626,00	€ 754,00	€ 830,00

Composition example: TRACK STAINLESS POLISHED STEEL

CODE	TRANSPARENT	COLOURED	COLOURED FUME (08)
1517.120.3L	€ 1.390,00	€ 1.522,00	€ 1.522,00

Description	LED (driver included)	Cable	Net weight kg	Gross weight kg	Package cm
Single pendant, glass Ø24 H7 cm - FOL9 canopy	LED 1 x 17,4W	150 cm	1,235	2,185	33 x 33 x 34
Single pendant, glass Ø36 H10 cm - FOL9 canopy	LED 1 x 17,4W	150 cm	1,835	3,035	41 x 41 x 32

Description	LED (driver included)	Cable	Net weight kg	Gross weight kg	Package cm
Single pendant without canopy, glass Ø24 H7 cm	LED 1 x 17,4W	150 cm	1,235	2,185	33 x 33 x 34
Single pendant without canopy, glass Ø36 H10 cm	LED 1 x 17,4W	150 cm	1,835	3,035	41 x 41 x 32

Description	LED (driver included)	Cable	Net weight kg	Gross weight kg	Package cm
Track AUF120 L120 cm, 3x glass Ø24 H7 cm	LED 3 x 17,4W	150 cm	4,590	7,830	10 x 10 x 162 / 3X 33 x 33 x 34

METAL STRUCTURE AVAILABLE: chrome, satin gold, satin black nickel

GLASS COLOUR AVAILABLE: transparent (01), bicolour shiny-tobacco

ERHAELTICHE AUSFÜHRUNGEN DER METALLTEILE: Chrom, Gold satiniert, schwarzes Nickel satiniert

ERHAELTICHE GLASFARBEN: transparent (01), zweifarbig glänzend-tabak (16)

ON DEMAND:
AUF ANFRAGE:

WITH UL COMPONENTS
+10% in addition

MIT UL KOMPONENTEN
+ 10% Aufpreis

Frequency L128 /150 cm

DIMMABLE: YES with additional device (NOT supplied)
DRIVER HLG-60H-20 "BLANK TYPE"

DIMMABLE: JA Mit zusätzlichem Treiber (NICHT im Lieferumfang enthalten)
TRAFO HLG-60H-20 "BLANK TYPE"

Frequency L63 cm

DIMMABLE: YES with additional device (NOT supplied)
DRIVER LPF-16-20

DIMMABLE: JA Mit zusätzlichem Treiber (NICHT im Lieferumfang enthalten)
TRAFO LPF-16-20

technical info
technische Information



- COAXIAL LOW VOLTAGE ELECTRIC CABLE IN TRANSPARENT

NIEDERVOLT KOAXIALKABEL IN TRANSPARENT

- STRUCTURE IN GALVANIZED BRASS

GALVANISIERTE MESSINGFASSUNG

- DIMMABLE: YES

DIMMBAR

- DRIVER INCLUDED

TRAFO INBEGRIFFEN

- LED IS REPLACEABLE BY THE MANUFACTURER

LED IST VOM HERSTELLER AUSTAUSCHBAR

LED AVAILABLE FOR FREQUENCY[®] SUSPENSION L128 cm: / ERHAELTICHE LEDS FUER FREQUENCY[®] SERIE L128 cm:

LED 21,6 W DIMM - 3245 Lm - 150,2 Lm/W - 1080 mA - CRI 95 - 20V - 2700°K or 3000°K

LUMEN INDICATED CORRESPONDS TO THE LUMINOUS INTENSITY AT THE ORIGIN OF THE LED BOARD
DIE ANGEGBENEN LUMEN ENTSPRECHEN DER LICHTINTENSITAET DER URSPRÜNGLICHEN LED-PLATINE

LED 21,6 W DIMM - 1350 Lm - 62,5 Lm/W - 1080mA - CRI 95 - 20V - 2700°K or 3000°K

LUMEN LUMINOUS INTENSITY WITH TRANSPARENT GLASS
LUMEN LICHTSTÄRKE MIT TRANSPARENTEM GLAS

LED AVAILABLE FOR FREQUENCY[®] SUSPENSION L150 cm: / ERHAELTICHE LEDS FUER FREQUENCY[®] SERIE L150 cm:

LED 24,48 W DIMM - 3677 Lm - 150,2 Lm/W - 1080 mA - CRI 95 - 20V - 2700°K or 3000°K

LUMEN INDICATED CORRESPONDS TO THE LUMINOUS INTENSITY AT THE ORIGIN OF THE LED BOARD
DIE ANGEGBENEN LUMEN ENTSPRECHEN DER LICHTINTENSITAET DER URSPRÜNGLICHEN LED-PLATINE

LED 24,48 W DIMM - 2400-2600 Lm - 100-105 Lm/W - 1080mA - CRI 95 - 20V - 2700°K or 3000°K

LUMEN LUMINOUS INTENSITY WITH TRANSPARENT GLASS
LUMEN LICHTSTÄRKE MIT TRANSPARENTEM GLAS

LED AVAILABLE FOR FREQUENCY[®] SUSPENSION L63 cm: / ERHAELTICHE LEDS FUER FREQUENCY[®] SERIE L63 cm:

LED 10,8 W DIMM - 1622 Lm - 150,2 Lm/W - 540 mA - CRI 95 - 20V - 2700°K or 3000°K

LUMEN INDICATED CORRESPONDS TO THE LUMINOUS INTENSITY AT THE ORIGIN OF THE LED BOARD
DIE ANGEGBENEN LUMEN ENTSPRECHEN DER LICHTINTENSITAET DER URSPRÜNGLICHEN LED-PLATINE

LED 10,8 W DIMM - 675 Lm - 62,5 Lm/W - 540mA - CRI 95 - 20V - 2700°K or 3000°K

LUMEN LUMINOUS INTENSITY WITH TRANSPARENT GLASS
LUMEN LICHTSTÄRKE MIT TRANSPARENTEM GLAS

WALL LAMP



CODE	TRANSPARENT	BICOLOUR
AP1551	€ 1.554,00	€ 1.710,00

HORIZONTAL SUSPENSION

CODE	TRANSPARENT	BICOLOUR
1553.OR.1	€ 2.855,00	€ 3.283,00
1553.OR.2	€ 2.875,00	€ 3.303,00
GIG1553.OR.2	€ 3.600,00	€ 3.960,00

Description	LED (driver included)		Net weight kg	Gross weight kg	Package cm
Wall lamp L15 - P21 - H70 cm	LED 1 x 10,8 W DIMM	/	2,370	4,870	86 x 26 x 32

Description	LED (driver included)	Cable	Net weight kg	Gross weight kg	Package cm
Horizontal suspension L128 - P17 - H17 cm Canopy 24x10xH5 - 1x spacers	LED 1 x 21,6 W DIMM	300 cm	2,750	4,950	27 x 27 x 138
Horizontal suspension L128 - P17 - H17 cm Canopy 24x10xH5 - 2x spacers	LED 1 x 21,6 W DIMM	350 cm	2,750	4,950	27 x 27 x 138
Horizontal suspension L150 - P22 - H22 cm Canopy 24x10xH5 - 2x	LED 1 x 24,48 W DIMM	300 cm	4,440	8,100	29 x 30 x 163

VERTICAL SUSPENSION



CODE	TRANSPARENT	BICOLOUR	
MINI1553.VE	€ 1.471,00	€ 1.618,00	
1553.VE	€ 2.855,00	€ 3.283,00	

VERTICAL SUSPENSION with shuko plug

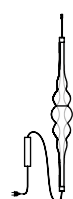

CODE	TRANSPARENT	BICOLOUR	
1555.VE	€ 2.940,00	€ 3.368,00	

Composition example: MULTIPLE SUSPENSION

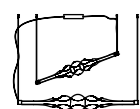

CODE	TRANSPARENT	BICOLOUR	
1553MX.2L	€ 6.475,00	€ 7.263,00	

Description	LED (driver included)	Cable	Net weight kg	Gross weight kg	Package cm
Vertical suspension L15 - P15 - H63 cm Canopy 15x4xH3 cm	LED 1 x 10,8 W DIMM	300 cm	1,970	4,470	86 x 26 x 32
Vertical suspension L17 - P17 - H128 cm Canopy 24x10xH5 cm	LED 1 x 21,6 W DIMM	300 cm	2,750	4,950	27 x 27 x 138

Description	LED (driver included)	Cable	Net weight kg	Gross weight kg	Package cm
Vertical suspension L17 - P17 - H128 cm Canopy 24x10xH5 cm - 1x spacer WITH PLUG	LED 1 x 21,6 W DIMM	200 cm	2,750	4,950	27 x 27 x 138

Descrizione	LED integrato	Cavo	Peso netto kg	Peso lordo kg	Imballo cm
1x Horizontal suspension L128 - P17 - H17 cm 1x Horizontal suspension L150 - P22 - H22 cm Canopy 24x10xH5 - 4x spacers	LED 1 x 21,6 W DIMM LED 1 x 24,48 W DIMM	200 cm 200 cm	7,200	13,100	27 x 27 x 138 29 x 30 x 163

METAL STRUCTURE AVAILABLE: chrome, brushed chrome, matt white, matt black

GLASS COLOUR AVAILABLE: transparent (01), pink (03), amber (05), green (06), sky-blue (07), fume (08), tobacco (16), ruby (17)

ERHAELTICHE AUSFÜHRUNGEN DER METALLTEILE: Chrom, Chrom gebürstet, Weiss matt, Schwarz Matt

ERHAELTICHE GLASFARBEN: transparent (01), rosa (03), bernstein (05), grün (06), hellblau (07), rauchfarben (08), tabak (16), rubinrot (17)

ON DEMAND:
AUF ANFRAGE:

WITH UL COMPONENTS
+10% in addition

MIT UL KOMPONENTEN
+ 10% Aufpreis

AVAILABLE WITH DALI
(ask for a quote)

ERHÄLTICH MIT DALI
(Angebot erfragen)

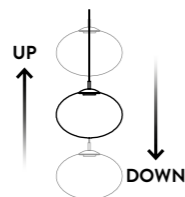

AVAILABLE WITH UP & DOWN SYSTEM (see price on page 105)

- AVAILABLE ONLY FOR GEO[®] GIG1543 XXL1543 (maximum weight 1,8 kg)
- CABLE AVAILABLE IN BLACK diam. 2,1 mm
- COAXIAL CABLE 0,24M2
- ADJUSTMENT: minimum length ca. 0,55 m / maximum length 1,90 m

ERHÄLTICH MIT UP&DOWN SYSTEM (siehe Preise Seite 105)

- NUR FUER GEO[®] GIG1543 XXL1543 ERHAELTICH (max. Gewicht 1,8 kg)
- KABEL ERHAELTICH IN SCHWARZ Durchm. 2,1 mm
- KOAXIALKABEL SCHWARZ 0,24M2
- HOEHENVERSTELLUNG: Mindestlaenge ca. 0,55 m - Max. Laenge 1,90 m

SINGLE PENDANT with canopy

CODE	TRANSPARENT	COLOURED	COLOURED FUME (08)
1543.1L	€ 337,00	€ 419,00	€ 419,00
GIG1543.1L	€ 404,00	€ 503,00	€ 551,00
XXL1543.1L	€ 493,00	€ 609,00	€ 668,00

* CODE without canopy for compositions

CODE	TRANSPARENT	COLOURED	COLOURED FUME (08)
1543	€ 313,00	€ 395,00	€ 395,00
GIG1543	€ 380,00	€ 479,00	€ 527,00
XXL1543	€ 469,00	€ 585,00	€ 644,00

Composition example: TRACK STAINLESS POLISHED STEEL

CODE	TRANSPARENT	COLOURED	COLOURED FUME (08)
1547.120.3L	€ 1.192,00	€ 1.438,00	€ 1.438,00

Composition example: PLATE STAINLESS POLISHED STEEL

CODE	TRANSPARENT	COLOURED	COLOURED FUME (08)
1549MX.43.3L	€ 1.440,00	€ 1.737,00	€ 1.844,00



* TO CREATE **CUSTOM COMPOSITIONS**, USE THE PRICES **WITHOUT CANOPY**
AND SELECT THE DESIRED STRUCTURE FROM PAGE 89 TO PAGE 105

- **COAXIAL LOW VOLTAGE ELECTRIC CABLE IN TRANSPARENT OR BLACK**
NIEDERVOLT KOAXIALKABEL IN TRANSPARENT ODER SCHWARZ

- **SMALL SINGLE CANOPY AVAILABLE IN: Satin gold, Satin rose gold, Satin black nickel - without surcharge**
BALDACHIN FUER EINZELPENDEL ERHAELTICH IN: Satin gold, Satin roségold, Satin schwarz nickel, ohne aufpreis

- **LAMPHOLDER AVAILABLE IN: Satin gold, Satin rose gold (with surcharge +40,00 €) - Satin black nickel (without surcharge)**
ERHAELTICHE LAMPENFASSUNGEN IN: Gold satiniert, Roségold satiniert (mit Aufschlag + 40,00 €) - Schwarz nickelsatiniert (ohne Aufpreis)

- **TRACKS AND PLATES AVAILABLE ONLY IN: Chrome, Matt white, Matt black, Brushed chrome**
SCHIENEN UND DECKENPLATTEN NUR ERHAELTICH IN: Chrom, Weiss matt, Schwarz matt, Chrom gebürstet

- **ALUMINUM LAMP HOLDER**
FASSUNG AUS ALUMINIUM

- **ONLY ON PRODUCTS GIG AND XXL IN FUME (08) COLOUR: 10% SURCHARGE ON THE PRICE OF THE COLOURED**
NUR FUER ARTIKEL GIG UND XXL IN FARBE RAUCHFARBEN (08): +10% AUFPREIS AUF "COLOURED" PREISE

- **COMPATIBLE WITH CASAMBI**
KOMPATIBEL MIT

- **DRIVER INCLUDED**
TRAFO INBEGRIFFEN

- **DIMMABLE: YES (PHASE-CUT DIMMER TRIAC) - LED IS REPLACEABLE BY PROFESSIONAL**
DIMMBAR: (PHASENABSCHNITT) LED-PLATINE VON FACHMANN AUSTAUSCHBAR

LEDS AVAILABLE FOR GEO[®] / ERHAELTICHE LEDS FUER GEO[®] SERIE:

LED 1 x 6W DIMM - 11,2-12,8 V - 500 mA - CRI >90 - 866 Lm - 144 Lm/W - 3 Step MacAdam - **2700°K**
LED 1 x 6W DIMM - 11,2-12,8 V - 500 mA - CRI >90 - 866 Lm - 144 Lm/W - 3 Step MacAdam - **3000°K**

LUMEN INDICATED CORRESPONDS TO THE LUMINOUS INTENSITY AT THE ORIGIN OF THE LED BOARD
DIE ANGEGEBENEN LUMEN ENTSPRECHEN DER LICHTINTENSITAET DER URSPRÜNGLICHEN LED-PLATINE

ON DEMAND: PRODUCTS CAN BE REQUIRED WITH *8,4W LED with surcharge of +70.00 €
AUF ANFRAGE: ARTIKEL SIND AUCH MIT *8,4W LEDS erhältlich (+70,00 Aufpreis)

*LED 1 x 8,4W DIMM - 22,4-24,8 V - 350 mA CRI >90 1202 Lm - 144 Lm/W - 3 Step MacAdam - **2700°K or 3000°K**

Description	LED (driver included)	Cable	Net weight kg	Gross weight kg	Package cm
Single pendant, glass Ø26 H18 cm - PT9 canopy	LED 1 x 6W DIMM	200 cm	0,900	1,900	29 x 29 x 47
Single pendant, glass Ø30 H20 cm - PT9 canopy	LED 1 x 6W DIMM	200 cm	1,100	2,300	41 x 41 x 42
Single pendant, glass Ø34 H24 cm - PT9 canopy	LED 1 x 6W DIMM	200 cm	2,400	4,300	41 x 41 x 42

Description	LED (driver included)	Cable	Net weight kg	Gross weight kg	Package cm
Single pendant without canopy, glass Ø26 H18 cm	LED 1 x 6W DIMM	200 cm	0,900	1,900	29 x 29 x 47
Single pendant without canopy, glass Ø30 H20 cm	LED 1 x 6W DIMM	200 cm	1,100	2,300	41 x 41 x 42
Single pendant without canopy, glass Ø34 H24 cm	LED 1 x 6W DIMM	200 cm	2,400	4,300	41 x 41 x 42

Description	LED (driver included)	Cable	Net weight kg	Gross weight kg	Package cm
Track AUF120 L120 cm, 3x glass Ø26 H18 cm	LED 3 x 6W DIMM	200 cm	3,760	5,780	10 x 10 x 162 / 3X 29 x 29 x 57

Description	LED (driver included)	Cable	Net weight kg	Gross weight kg	Package cm
Plate P43 Ø43 cm, glass Ø26-30-34 cm	LED 3 x 6W DIMM	200 cm	6,820	9,200	51 x 51 x 14 / 29 x 29 x 47 2X 41 x 41 x 42

METAL STRUCTURE AVAILABLE: black carbon, champagne, french gold

GLASS COLOUR AVAILABLE: transparent (01), pink (03), amber (05), green (06), sky-blue (07), fume (08), tobacco (16), ruby (17)

ERHAELTICHE AUSFÜHRUNGEN DER METALLTEILE: black carbon, champagne, french gold

ERHAELTICHE GLASFARBEN: transparent (01), rosa (03), bernstein (05), grün (06), hellblau (07), rauchfarben (08), tabak (16), rubinrot (17)

**A RICHIESTA:
ON DEMAND:**

**WITH UL COMPONENTS
+10% in addition**

MIT UL KOMPONENTEN
+ 10% Aufpreis

**AVAILABLE WITH DALI
(ask for a quote)**

ERHÄLTICH MIT DALI
(Angebot erfragen)

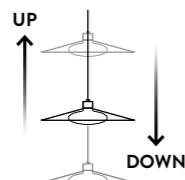

AVAILABLE WITH UP & DOWN SYSTEM (see price on page 105)

- AVAILABLE ONLY FOR HYDRA[®] GIG1633 (maximum weight 1,8 kg)
- CABLE AVAILABLE IN BLACK diam. 2,1 mm
- COAXIAL CABLE 0,24M2
- ADJUSTMENT: minimum length ca. 0,55 m / maximum length 1,90 m

ERHÄLTICH MIT UP&DOWN SYSTEM (siehe Preise Seite 105)

- NUR FUER HYDRA[®] GIG1633 (max. Gewicht 1,8 kg)
- KABEL ERHAELTICH IN SCHWARZ Durchm. 2,1 mm
- KOAXIALKABEL SCHWARZ 0,24M2
- HOEHENVERSTELLUNG: Mindestlaenge ca. 0,55 m - Max. Laenge 1,90 m

WALL LAMP

CODE	TRANSPARENT	COLOURED	COLOURED FUME (08)
AP1631.1L	€ 450,00	€ 517,00	€ 517,00
APGIG1631.1L	€ 645,00	€ 741,00	€ 815,00

CEILING LAMP

CODE	TRANSPARENT	COLOURED	COLOURED FUME (08)
1636.1L	€ 450,00	€ 517,00	€ 517,00
GIG1636.1L	€ 645,00	€ 741,00	€ 815,00



* TO CREATE **CUSTOM COMPOSITIONS**, USE THE PRICES **WITHOUT CANOPY**
AND SELECT THE DESIRED STRUCTURE FROM PAGE 89 TO PAGE 105

- **BLACK FEP OR TRANSPARENT SILICONE ELECTRIC CABLE** on demand: brown/ red, without surcharge
SCHWARZES FEP- ODER DURCHSCHNITTLICHES SILIKON-STROMKABEL auf Anfrage: braun/ rot, ohne Aufpreis

- **STRUCTURE AVAILABLE IN:** black carbon, champagne, french gold
RAHMEN ERHAELTICH IN: black carbon, champagne, french gold

- **TRACKS AND PLATES AVAILABLE ONLY IN:** black carbon, champagne, french gold
SCHIENEN UND DECKENPLATTEN NUR ERHAELTICH IN: black carbon, champagne, french gold

- **ALUMINIUM LAMP HOLDER**
FASSUNG AUS ALUMINIUM

- **COMPATIBLE WITH CASAMBI**
KOMPATIBEL MIT

- **DRIVER INCLUDED**
TRAFO INBEGRIFFEN

- **DIMMABLE: YES (PHASE-CUT DIMMER TRIAC) - LED IS REPLACEABLE BY PROFESSIONAL**
DIMMBAR: (PHASENABSCHNITT) LED-PLATINE VON FACHMANN AUSTAUSCHBAR

LEDS AVAILABLE FOR HYDRA[®] / ERHAELTICHE LEDS FUER HYDRA[®]SERIE:

LED 1 x 9W Dimmer Triac - 27 V - 350 mA - CRI Typ 95 - 1125 Lm - 125 Lm/W - 3 Step MacAdam - **2700°K**
LED 1 x 9W Dimmer Triac - 27 V - 350 mA - CRI Typ 95 - 1125 Lm - 125 Lm/W - 3 Step MacAdam - **3000°K**

LEDS AVAILABLE FOR HYDRA[®] GIG / ERHAELTICHE LEDS FUER HYDRA[®]GIG SERIE:

LED 1 x 12W Dimmer Triac - 36 V - 350 mA - CRI Typ 95 - 1500 Lm - 125 Lm/W - 3 Step MacAdam - **2700°K**
LED 1 x 12W Dimmer Triac - 36 V - 350 mA - CRI Typ 95 - 1500 Lm - 125 Lm/W - 3 Step MacAdam - **3000°K**

LEDS AVAILABLE FOR HYDRA[®] XXL / ERHAELTICHE LEDS FUER HYDRA[®]XXL SERIE:

LED 1 x 15W Dimmer Triac - 45 V - 350 mA - CRI Typ 95 - 1875 Lm - 125 Lm/W - 3 Step MacAdam - **2700°K**
LED 1 x 15W Dimmer Triac - 45 V - 350 mA - CRI Typ 95 - 1875 Lm - 125 Lm/W - 3 Step MacAdam - **3000°K**

LUMEN INDICATED CORRESPONDS TO THE LUMINOUS INTENSITY AT THE ORIGIN OF THE LED BOARD
DIE ANGEgebenEN LUMEN ENTSPRECHEN DER LICHTINTENSITAET DER URSPRUENGLICHEN LED-PLATINE

Description	LED (driver included)		Net weight kg	Gross weight kg	Package cm
Wall lamp glass Ø17 cm P9 H25 cm	LED 1 x 9W DIMM	/	0,650	1,600	33 x 33 x 24
Wall lamp glass Ø24 cm P12 H36 cm	LED 1 x 12W DIMM	/	1,050	2,500	41 x 41 x 42

Description	LED (driver included)		Net weight kg	Gross weight kg	Package cm
Ceiling lamp Ø25 H9 cm	LED 1 x 9W DIMM	/	0,650	1,600	33 x 33 x 24
Ceiling lamp Ø36 H12 cm	LED 1 x 12W DIMM	/	1,050	2,500	41 x 41 x 42

SINGLE PENDANT with canopy

CODE	TRANSPARENT	COLOURED	COLOURED FUME (08)
1633.1L	€ 455,00	€ 523,00	€ 523,00
GIG1633.1L	€ 620,00	€ 713,00	€ 785,00
XXL1633.1L	€ 1.248,00	€ 1.435,00	€ 1.579,00

* CODE without canopy for compositions

CODE	TRANSPARENT	COLOURED	COLOURED FUME (08)
1633	€ 431,00	€ 499,00	€ 499,00
GIG1633	€ 596,00	€ 689,00	€ 758,00
XXL1633	€ 1.224,00	€ 1.411,00	€ 1.552,00

Composition example: TRACK STAINLESS POLISHED STEEL

CODE	TRANSPARENT	COLOURED	COLOURED FUME (08)
1637.120.3L	€ 1.546,00	€ 1.750,00	€ 1.750,00

Description	LED (driver included)		Net weight kg	Gross weight kg	Package cm
Single pendant, glass Ø25 cm - FOL9 canopy	LED 1 x 9W DIMM	/	0,650	1,600	26 x 26 x 47
Single pendant, glass Ø36 cm - FOL9 canopy	LED 1 x 12W DIMM	/	1,050	2,500	41 x 41 x 42
Single pendant, glass Ø55 cm - FOL9 canopy	LED 1 x 15W DIMM	/	2,200	4,200	66 x 66 x 31,5

Description	LED (driver included)	Cable	Net weight kg	Gross weight kg	Package cm
Single pendant without canopy, glass Ø25 cm H 5	LED 1 x 9W DIMM	200 cm	0,450	1,400	26 x 26 x 47
Single pendant without canopy, glass Ø36 cm H 9	LED 1 x 12W DIMM	200 cm	0,850	2,300	29 x 29 x 57
Single pendant without canopy, glass Ø55 cm H 12	LED 1 x 15W DIMM	200 cm	2,000	4,000	66 x 66 x 31,5

Descrizione	LED integrato	Cavo	Peso netto kg	Peso lordo kg	Imballo cm
Track AUF120 L120 cm, 3 x glass Ø25 cm	LED 3 x 9W DIMM	200 cm	3,650	5,650	10 x 10 x 162 3X 26 x 26 x 47

LACRIMA[©] smooth glass

METAL STRUCTURE AVAILABLE: chrome

GLASS COLOUR AVAILABLE: transparent (01), pink (03), amber (05), green (06), sky-blue (07), fume (08), tobacco (16), ruby (17)

ERHAETLICHE AUSFÜHRUNGEN DER METALLTEILE: Chrom

ERHAETLICHE GLASFARBEN: transparent (01), rosa (03), bernstein (05), grün (06), hellblau (07), rauchfarben (08), tabak (16), rubinrot (17)

SINGLE PENDANT with canopy



CODE	TRANSPARENT	COLOURED	COLOURED FUME (08)
1253.1L	€ 257,00	€ 308,00	€ 308,00
GIG1253.1L	€ 381,00	€ 457,00	€ 501,00

* CODE without canopy for compositions



CODE	TRANSPARENT	COLOURED	COLOURED FUME (08)
1253	€ 233,00	€ 284,00	€ 284,00
GIG1253	€ 357,00	€ 433,00	€ 477,00

Composition example: MULTIPLE SUSPENSION LAMP



CODE	TRANSPARENT	COLOURED	COLOURED FUME (08)
1253.2L	€ 545,00	€ 647,00	€ 647,00

Composition example: TRACK STAINLESS POLISHED STEEL

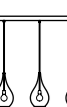

CODE	TRANSPARENT	COLOURED	COLOURED FUME (08)
1257.120.3L	€ 952,00	€ 1.105,00	€ 1.105,00

Composition example: PLATE STAINLESS POLISHED STEEL

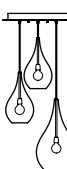

CODE	TRANSPARENT	COLOURED	COLOURED FUME (08)
1259MX.3L	€ 1.101,00	€ 1.279,00	€ 1.323,00



* TO CREATE **CUSTOM COMPOSITIONS**, USE THE PRICES **WITHOUT CANOPY** AND SELECT THE DESIRED STRUCTURE FROM PAGE 89 TO PAGE 105

- **TRANSPARENT ELECTRIC CABLE**
TRANSPARENTES KABEL

- **ON DEMAND: HANGING LAMPS WITH E14 CAN BE MADE WITH E27, without surcharge**
AUF ANFRAGE: PENDELLEUCHTE E14 KANN AUCH MIT FASSUNG E27 GEFERTIGT WERDEN, ohne aufpreis

- **ONLY ON PRODUCT GIG IN FUME (08) COLOUR: 10% SURCHARGE ON THE PRICE OF THE COLOURED**
NUR FUER ARTIKEL GIG IN FARBE RAUCHFARBEN (08): +10% AUFPREIS AUF "COLOURED" PREISE

- **ON DEMAND: WITH UL COMPONENTS +10% in addition**
AUF ANFRAGE: MIT UL KOMPONENTEN + 10% Aufpreis

Description	Bulb (not included)	Cable	Net weight kg	Gross weight kg	Package cm
Single pendant, glass Ø18 H32 cm - LAC10 canopy	E14 1 x max 42W	150 cm	0,820	1,800	26 x 26 x 47
Single pendant, glass Ø26 H42 cm - LAC10 canopy	E27 1 x max 70W	150 cm	1,085	2,100	29 x 29 x 57

Description	Bulb (not included)	Cable	Net weight kg	Gross weight kg	Package cm
Single pendant without canopy, glass Ø18 H32 cm	E14 1 x max 42W	150 cm	0,820	1,800	26 x 26 x 47
Single pendant without canopy, glass Ø26 H42 cm	E27 1 x max 70W	150 cm	1,085	2,100	29 x 29 x 57

Description	Bulb (not included)	Cable	Net weight kg	Gross weight kg	Package cm
Susp. composed of 2 glasses Ø18 cm - GOC10/M canopy - 2x WS2	E14 2 x max 42W	250 cm	1,540	3,200	41 x 42 x 42

Description	Bulb (not included)	Cable	Net weight kg	Gross weight kg	Package cm
Track AUF120 L120 cm, 3x glass Ø18 H32 cm	E14 3 x max 42W	150 cm	3,400	6,250	10 x 10 x 162 / 43 x 43 x 54

Description	Bulb (not included)	Cable	Net weight kg	Gross weight kg	Package cm
Plate P43 Ø43 cm, glass 2x Ø18 - 1x Ø26 cm	E14 2x max 42W E27 1x max 70W	150 cm	4,600	7,400	51 x 51 x 14 / 43 x 43 x 54

LACRIMA[®] ribbed glass

METAL STRUCTURE AVAILABLE: chrome

GLASS COLOUR AVAILABLE: transparent (01), pink (03), amber (05), green (06), sky-blue (07), fume (08), tobacco (16), ruby (17)

ERHAETLICHE AUSFÜHRUNGEN DER METALLTEILE: Chrom

ERHAETLICHE GLASFARBEN: transparent (01), rosa (03), bernstein (05), grün (06), hellblau (07), rauchfarben (08), tabak (16), rubinrot (17)

TABLE LAMP



CODE	TRANSPARENT	COLOURED	COLOURED FUME (08)
RLU1250	€ 312,00	€ 373,00	€ 373,00
RLUGIG1250	€ 532,00	€ 609,00	€ 670,00

SINGLE PENDANT with canopy



CODE	TRANSPARENT	COLOURED	COLOURED FUME (08)
R1253.1L	€ 282,00	€ 337,00	€ 337,00
RGIG1253.1L	€ 417,00	€ 498,00	€ 546,00

* CODE without canopy for compositions



CODE	TRANSPARENT	COLOURED	COLOURED FUME (08)
R1253	€ 258,00	€ 313,00	€ 313,00
RGIG1253	€ 393,00	€ 474,00	€ 522,00

Composition example: MULTIPLE SUSPENSION LAMP



CODE	TRANSPARENT	COLOURED	COLOURED FUME (08)
R1253.2L	€ 595,00	€ 705,00	€ 705,00

Composition example: TRACK STAINLESS POLISHED STEEL



CODE	TRANSPARENT	COLOURED	COLOURED FUME (08)
R1257.120.3L	€ 1.027,00	€ 1.192,00	€ 1.192,00

Composition example: PLATE STAINLESS POLISHED STEEL



CODE	TRANSPARENT	COLOURED	COLOURED FUME (08)
R1259MX.3L	€ 1.187,00	€ 1.378,00	€ 1.426,00



* TO CREATE **CUSTOM COMPOSITIONS**, USE THE PRICES **WITHOUT CANOPY** AND SELECT THE DESIRED STRUCTURE FROM PAGE 89 TO PAGE 105

- TRANSPARENT ELECTRIC CABLE

TRANSPARENTES KABEL

- ON DEMAND: HANGING LAMPS WITH E14 CAN BE MADE WITH E27, without surcharge

AUF ANFRAGE: PENDELLEUCHTE E14 KANN AUCH MIT FASSUNG E27 GEFERTIGT WERDEN, ohne aufpreis

- ONLY ON PRODUCT GIG IN FUME (08) COLOUR: 10% SURCHARGE ON THE PRICE OF THE COLOURED NUR FUER ARTIKEL GIG IN FARBE RAUCHFARBEN (08): +10% AUFPREIS AUF "COLOURED" PREISE

- AVAILABLE FABRIC SHADES FOR TABLE LAMPS: IVORY PONGÈ WITH LOW TRIMMING / IVORY PONGÈ WITH HIGH TRIMMING
ERHAETLICHE LAMPENSCHIRME FUER TISCHLEUCHTEN: IVORY PONGE MIT NIEDRIGER NAHT / IVORY PONGE MIT HOHER NAHTICHE

- ON DEMAND: WITH UL COMPONENTS +10% in addition

AUF ANFRAGE: MIT UL KOMPONENTEN +10% Aufpreis

Description	Bulb (not included)	Cable	Net weight kg	Gross weight kg	Package cm
Table lamp Ø30 - H55 cm	E14 1 x max 40W	200 cm	0,970	1,970	43 x 43 x 54
Table lamp Ø40 - H70 cm	E27 1 x max 60W	200 cm	1,480	2,480	43 x 43 x 64

Description	Bulb (not included)	Cable	Net weight kg	Gross weight kg	Package cm
Single pendant, glass Ø18 H32 cm - LAC10 canopy	E14 1 x max 42W	150 cm	0,820	1,800	26 x 26 x 47
Single pendant, glass Ø26 H42 cm - LAC10 canopy	E27 1 x max 70W	150 cm	1,085	2,100	29 x 29 x 57

Description	Bulb (not included)	Cable	Net weight kg	Gross weight kg	Package cm
Single pendant without canopy, glass Ø18 H32 cm	E14 1 x max 42W	150 cm	0,820	1,800	26 x 26 x 47
Single pendant without canopy, glass Ø26 H42 cm	E27 1 x max 70W	150 cm	1,085	2,100	29 x 29 x 57

Description	Bulb (not included)	Cable	Net weight kg	Gross weight kg	Package cm
Susp. composed of 2 glasses Ø18 cm - GOC10/M canopy - 2x WS2	E14 2 x max 42W	250 cm	1,540	3,200	41 x 42 x 42

Description	Bulb (not included)	Cable	Net weight kg	Gross weight kg	Package cm
Track AUF120 L120 cm, 3x glass Ø18 H32 cm	E14 3 x max 42W	150 cm	3,400	6,250	10 x 10 x 162 / 43 x 43 x 54

Description	Bulb (not included)	Cable	Net weight kg	Gross weight kg	Package cm
Plate P43 Ø43 cm, glass 2x Ø18 - 1x Ø26 cm	E14 2x max 42W E27 1x max 70W	150 cm	4,600	7,400	51 x 51 x 14 / 43 x 43 x 54

METAL STRUCTURE AVAILABLE: chrome, matt black, satin black nickel, satin gold

GLASS COLOUR AVAILABLE: transparent (01), pink (03), amber (05), green (06), sky-blue (07), fume (08), tobacco (16), ruby (17)

ERHAELTICHE AUSFÜHRUNGEN DER METALLTEILE: Chrom, Schwarz Matt, Schwarzes nikel satiniert, Gold satiniert

ERHAELTICHE GLASFARBEN: transparent (01), rosa (03), bernstein (05), grün (06), hellblau (07), rauchfarben (08), tabak (16), rubinrot (17)

ON DEMAND:
AUF ANFRAGE:

WITH UL COMPONENTS
+10% in addition

MIT UL KOMPONENTEN
+ 10% Aufpreis

AVAILABLE WITH DALI
(ask for a quote)

ERHÄLTICH MIT DALI
(Angebot erfragen)

WALL LAMP

CODE	TRANSPARENT	COLOURED nuanced	COLOURED nuanced FUME (08)
AP1591.20.1L	€ 535,00	€ 590,00	€ 598,00

CEILING LAMP

CODE	TRANSPARENT	COLOURED nuanced	COLOURED nuanced FUME (08)
1596.26.1L	€ 725,00	€ 830,00	€ 870,00
1596.30.1L	€ 845,00	€ 970,00	€ 996,00

SINGLE PENDANT with canopy

CODE	TRANSPARENT	COLOURED nuanced	COLOURED nuanced FUME (08)
1593.1L	€ 520,00	€ 580,00	€ 598,00
GIG1593.1L	€ 710,00	€ 816,00	€ 852,00
XXL1593.1L	€ 830,00	€ 954,00	€ 996,00

*** CODE without canopy** for compositions

CODE	TRANSPARENT	COLOURED nuanced	COLOURED nuanced FUME (08)
1593	€ 496,00	€ 556,00	€ 574,00
GIG1593	€ 686,00	€ 792,00	€ 828,00
XXL1593	€ 806,00	€ 930,00	€ 972,00



* TO CREATE **CUSTOM COMPOSITIONS**, USE THE PRICES **WITHOUT CANOPY**
AND SELECT THE DESIRED STRUCTURE FROM PAGE 89 TO PAGE 105

- BLACK RUBBER OR TRANSPARENT ELECTRIC CABLE

SCHWARZES KABEL AUS GUMMI ODER TRANSPARENTE

- SMALL SINGLE CANOPY AVAILABLE IN: Satin gold, Satin black nickel - without surcharge
EINZEL BALDACHINE ERHAELTLICH IN: Gold satiniert, Schwarzes nikel satiniert - ohne aufpreis

- LAMPHOLDER AVAILABLE IN: Satin gold, Satin rose gold, Satin black nickel - without surcharge
LAMPHOLDER AVAILABLE IN: Satin gold, Satin rose gold, Satin black nickel - without surcharge

- TRACKS AND PLATES AVAILABLE ONLY IN: Chrome, Matt white, Matt black, Brushed chrome
SCHIENEN UND DECKENPLATTEN NUR ERHAELTLICH IN: Chrom, Weiss matt, Schwarz matt, Chrom gebürstet

- PRODUCTS IN FUME (08) COLOUR: SURCHARGE ON THE PRICE OF THE COLOURED
FUER ARTIKEL IN FARBE RAUCHFARBEN (08): AUFPREIS AUF "COLOURED" PREISE

- COMPATIBLE WITH
KOMPATIBEL MIT **CASAMBI**

- DRIVER INCLUDED
TRAFO INBEGRIFFEN

- DIMMABLE: YES (PHASE-CUT DIMMER TRIAC) - LED IS REPLACEABLE BY PROFESSIONAL
DIMMBAR: (PHASENABSCHNITT) LED-PLATINE VON FACHMANN AUSTAUSCHBAR

LED AVAILABLE FOR LA STILLA® / ERHAELTICHE LEDS FUER LA STILLA® SERIE:

LED 1 x 8,4W DIMM - 22,4-24,8 V - 350 mA - CRI >90 - 1202 Lm - 144 Lm/W - 3 Step MacAdam - 2700°K
LED 1 x 8,4W DIMM - 22,4-24,8 V - 350 mA - CRI >90 - 1202 Lm - 144 Lm/W - 3 Step MacAdam - 3000°K

LEDS AVAILABLE FOR LA STILLA® **GIG E XXL** / ERHAELTICHE LEDS FUER LA STILLA® **GIG UND XXL** SERIE:

LED 12,8W Dimmer Triac - 1615 Lm -126 Lm/W - IP20 - CC 350mA - CRI Typ.95 - 32-40V - 180° - 2700°K
LED 12,8W Dimmer Triac - 1615 Lm -126 Lm/W - IP20 - CC 350mA - CRI Typ.95 - 32-40V - 180° - 3000°K

LUMEN INDICATED CORRESPONDS TO THE LUMINOUS INTENSITY AT THE ORIGIN OF THE LED BOARD
DIE ANGEGBENEN LUMEN ENTSPRECHEN DER LICHTINTENSITAET DER URSPRÜNGLICHEN LED-PLATINE

Description	LED (driver included)		Net weight kg	Gross weight kg	Package cm
Wall lamp L20 P25 H20 cm	LED 1 x 8,4W	/	0,894	1,504	26 x 26 x 36

Description	LED (driver included)		Net weight kg	Gross weight kg	Package cm
Celing lamp Ø26 H30 cm	LED 1 x 12,8W	/	1,225	1,955	29 x 29 x 48
Celing lamp Ø30 H35 cm	LED 1 x 12,8W	/	1,305	2,305	40 x 40 x 42

Description	LED (driver included)	Cable	Net weight kg	Gross weight kg	Package cm
Single pendant, glass Ø20 H22 cm - PT9 canopy	LED 1 x 8,4W	150 cm	0,894	1,504	26 x 26 x 36
Single pendant, glass Ø26 H28 cm - PT9 canopy	LED 1 x 12,8W	150 cm	1,225	1,955	29 x 29 x 48
Single pendant, glass Ø30 H32 cm - PT9 canopy	LED 1 x 12,8W	150 cm	1,305	2,305	40 x 40 x 42

Description	LED (driver included)	Cable	Net weight kg	Gross weight kg	Package cm
Single pendant without canopy, glass Ø20 H22 cm	LED 1 x 8,4W	150 cm	0,694	1,304	26 x 26 x 36
Single pendant without canopy, glass Ø26 H28 cm	LED 1 x 12,8W	150 cm	1,025	1,755	29 x 29 x 48
Single pendant without canopy, glass Ø30 H32 cm	LED 1 x 12,8W	150 cm	1,105	2,105	40 x 40 x 42

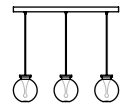
Composition example: TRACK STAINLESS POLISHED STEEL

CODE	TRANSPARENT	COLOURED nuanced	COLOURED nuanced FUME (08)
1597.120.3L	€ 1.741,00	€ 1.921,00	€ 1.975,00

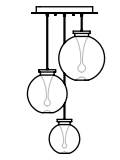
Composition example: PLATE STAINLESS POLISHED STEEL

CODE	TRANSPARENT	COLOURED nuanced	COLOURED nuanced FUME (08)
1599MX.43.3L	€ 2.266,00	€ 2.556,00	€ 2.652,00

Description	LED (driver included)	Cable	Net weight kg	Gross weight kg	Package cm
Track AUF120 L120 cm, 3x glass Ø20 H22 cm	LED 3 x 8,4W	150 cm	4,582	5,582	10 x 10 x 162 / 26 x 26 x 36 29 x 29 x 48 / 40 x 40 x 42

Description	LED (driver included)	Cable	Net weight kg	Gross weight kg	Package cm
Plate P43 Ø43 cm, glass Ø20-26-30 cm	LED 1 x 8,4W LED 2 x 12,8W	150 cm	5,324	8,664	51 x 51 x 14 / 26 x 26 x 36 29 x 29 x 48 / 40 x 40 x 42

METAL STRUCTURE AVAILABLE: satin gold, satin rose gold, satin black nickel

GLASS COLOUR AVAILABLE: transparent (01), pink (03), amber (05), green (06), sky-blue (07), fume (08), tobacco (16), ruby (17)

ERHAETLICHE AUSFÜHRUNGEN DER METALLTEILE: *Satin Gold, Satin Roségold, Satin Schwarz Nickel*

ERHAETLICHE GLASFARBEN: *transparent (01), rosa (03), bernstein (05), grün (06), hellblau (07), rauchfarben (08), tabak (16), rubinrot (17)*

TABLE LAMP



CODE	TRANSPARENT	COLOURED	
LU1570.1L	€ 229,00	€ 275,00	

WALL LAMP



CODE	TRANSPARENT	COLOURED	
AP1571.14.1L	€ 208,00	€ 236,00	
AP1571.18.1L	€ 219,00	€ 262,00	
AP1571.12.2L	€ 309,00	€ 370,00	

CEILING LAMP



CODE	TRANSPARENT	COLOURED	
1576.14.1L	€ 208,00	€ 236,00	
1576.18.1L	€ 219,00	€ 262,00	

SINGLE PENDANT with canopy



CODE	TRANSPARENT	COLOURED	
1573.14.1L	€ 230,00	€ 259,00	
1573.18.1L	€ 241,00	€ 284,00	

CHANDELIER



CODE	TRANSPARENT	COLOURED	
1574.9L	€ 1.675,00	€ 1.885,00	
1574.12L	€ 2.090,00	€ 2.371,00	
1574.9+3/12L	€ 2.019,00	€ 2.299,00	
1574.12+4/16L	€ 2.608,00	€ 2.981,00	

LINEAR CHANDELIER



CODE	TRANSPARENT	COLOURED	
1574.10L.LIN	€ 1.803,00	€ 2.036,00	
1574.12L.LIN	€ 2.164,00	€ 2.444,00	



* TO CREATE **CUSTOM COMPOSITIONS**, USE THE PRICES **WITHOUT CANOPY**
AND SELECT THE DESIRED STRUCTURE FROM PAGE 89 TO PAGE 105

- STRUCTURE IN GALVANIZED BRASS

GALVANISIERTER MESSINGFASSUNG

- ON DEMAND: THE CHANDELIER CAN BE MADE WITH CUSTOMIZED HEIGHT
(extending the metal pipe between the chandelier and the canopy)

AUF ANFRAGE: GESAMTHÖHE DES KRONLEUCHTERS KANN NACH MASS ANGEFERTIGT WERDEN
(Stab zwischen Kronleuchte und Baldachin kann nach Wunsch verlängert werden)

- ON DEMAND: WITH UL COMPONENTS +10% in addition

AUF ANFRAGE: MIT UL KOMPONENTEN + 10% Aufpreis

Description	Bulb (not included)	Cable	Net weight kg	Gross weight kg	Package cm
Table lamp Ø18 - H21 cm	G9 1 x max 33W	200 cm	0,800	1,600	26 x 26 x 37

Description	Bulb (not included)		Net weight kg	Gross weight kg	Package cm
Wall lamp Ø14 P17 H14 cm - 1 bulb	G9 1 x max 33W	/	0,400	0,800	38 x 18 x 19
Wall lamp Ø18 P21 H18 cm - 1 bulb	G9 1 x max 33W	/	0,500	1,300	26 x 26 x 37
Wall lamp L12 - P16 - H37 cm - 2 bulbs	G9 2 x max 33W	/	0,700	1,300	55 x 21 x 19

Description	Bulb (not included)		Net weight kg	Gross weight kg	Package cm
Ceiling lamp Ø14 H17 cm	G9 1 x max 33W	/	0,400	0,800	38 x 18 x 19
Ceiling lamp Ø18 H21 cm	G9 1 x max 33W	/	0,500	1,300	26 x 26 x 37

Description	Bulb (not included)	Cable	Net weight kg	Gross weight kg	Package cm
Single pendant Ø14 cm - GOC10 canopy in galvanized brass	G9 1 x max 33W	150 cm	0,450	0,850	38 x 18 x 19
Single pendant Ø18 cm - GOC10 canopy in galvanized brass	G9 1 x max 33W	150 cm	0,550	1,350	26 x 26 x 37

Description	Bulb (not included)		Net weight kg	Gross weight kg	Package cm
Chandelier Ø93 H83 cm - 9 bulbs	G9 9 x max 33W	/	4,500	10,000	101 x 101 x 43
Chandelier Ø93 H83 cm - 12 bulbs	G9 12 x max 33W	/	6,000	11,600	101 x 101 x 43
Chandelier Ø105 H83 cm - 12 bulbs	G9 12 x max 33W	/	5,200	13,000	101 x 101 x 43
Chandelier Ø105 H83 cm - 16 bulbs	G9 16 x max 33W	/	7,100	13,500	101 x 101 x 43

Description	Bulb (not included)		Net weight kg	Gross weight kg	Package cm
Linear chandelier L115 P57 H85 cm - 10 bulbs	G9 10 x max 33W	/	4,900	12,500	101 x 101 x 60
Linear chandelier L155 P61 H85 cm - 12 bulbs	G9 12 x max 33W	/			39 x 39 x 56 / 43 x 43 x 113

PARIGI[®] CIPOLLA smooth glass

METAL STRUCTURE AVAILABLE: chrome

GLASS COLOUR AVAILABLE: transparent (01), pink (03), amber (05), green (06), sky-blue (07), fume (08), tobacco (16), ruby (17)

ERHAELTICHE AUSFÜHRUNGEN DER METALLTEILE: Chrom

ERHAELTICHE GLASFARBEN: transparent (01), rosa (03), bernstein (05), grün (06), hellblau (07), rauchfarben (08), tabak (16), rubinrot (17)

TABLE LAMP

CODE	TRANSPARENT	COLOURED	COLOURED FUME (08)
LU1213	€ 285,00	€ 340,00	€ 340,00
LUGIG1213	€ 467,00	€ 555,00	€ 611,00
LUXXL1213	€ 742,00	€ 874,00	€ 962,00

WALL LAMP

CODE	TRANSPARENT	COLOURED	COLOURED FUME (08)
AP1211.1L	€ 201,00	€ 240,00	€ 240,00

SINGLE PENDANT with canopy

CODE	TRANSPARENT	COLOURED	COLOURED FUME (08)
1213.1L	€ 182,00	€ 219,00	€ 219,00
MED1213.1L	€ 271,00	€ 325,00	€ 325,00
GIG1213.1L	€ 319,00	€ 380,00	€ 416,00
XXL1213.1L	€ 605,00	€ 723,00	€ 793,00

* **CODE without canopy** for compositions

CODE	TRANSPARENT	COLOURED	COLOURED FUME (08)
1213	€ 158,00	€ 195,00	€ 195,00
MED1213	€ 247,00	€ 301,00	€ 301,00
GIG1213	€ 295,00	€ 356,00	€ 392,00
XXL1213	€ 581,00	€ 699,00	€ 769,00

Composition example: PLATE STAINLESS POLISHED STEEL

CODE	TRANSPARENT	COLOURED	COLOURED FUME (08)
1219MX.3L	€ 1.312,00	€ 1.528,00	€ 1.634,00



* TO CREATE **CUSTOM COMPOSITIONS**, USE THE PRICES **WITHOUT CANOPY** AND SELECT THE DESIRED STRUCTURE FROM PAGE 89 TO PAGE 105

- **TRANSPARENT ELECTRIC CABLE**

TRANSPARENTES KABEL

- **ONLY ON PRODUCTS GIG AND XXL IN FUME (08) COLOUR: 10% SURCHARGE ON THE PRICE OF THE COLOURED**
NUR FUER ARTIKEL GIG UND XXL IN FARBE RAUCHFARBEN (08): +10% AUFPREIS AUF "COLOURED" PREISE

- **AVAILABLE "LINO OLANDA" FABRIC SHADES FOR TABLE LAMPS: WHITE, CREAM, DOVE GRAY**
HOLLAND LEINEN LAMPENSCHIRME ERHAELTICH FUER TISCHLEUCHTEN: WEISS, CREME, GRAU-TAUBE

- **ON DEMAND: WITH UL COMPONENTS +10% in addition**
AUF ANFRAGE: MIT UL KOMPONENTEN + 10% Aufpreis

Description	Bulb (not included)	Cable	Net weight kg	Gross weight kg	Package cm
Table lamp Ø16 - H30 cm	E14 1 x max 40W	200 cm	0,520	1,000	26 x 26 x 47
Table lamp Ø30 - H53 cm	E27 1 x max 60W	200 cm	1,650	3,700	2X 41 x 41 x 42
Table lamp Ø38 - H63 cm	E27 1 x max 60W	200 cm	2,640	6,200	41 x 41 x 42 / 43 x 43 x 64

Description	Bulb (not included)	Cable	Net weight kg	Gross weight kg	Package cm
Wall lamp L15 P19 H23 cm	E14 1 x max 42W	/	0,450	0,900	38 x 18 x 19

Description	Bulb (not included)	Cable	Net weight kg	Gross weight kg	Package cm
Single pendant, glass Ø16 H12 cm - LAC10 canopy	E14 1 x max 42W	150 cm	0,450	0,900	38 x 18 x 19
Single pendant, glass Ø22 H15 cm - LAC10 canopy	E27 1 x max 70W	150 cm	1,100	2,100	26 x 26 x 47
Single pendant, glass Ø30 H19 cm - LAC10 canopy	E27 1 x max 70W	150 cm	1,400	2,500	41 x 41 x 42
Single pendant, glass Ø38 H25 cm - LAC10 canopy	E27 1 x max 70W	150 cm	2,400	4,200	41 x 41 x 42

Description	Bulb (not included)	Cable	Net weight kg	Gross weight kg	Package cm
Single pendant without canopy, glass Ø16 H12 cm	E14 1 x max 42W	150 cm	0,450	0,900	38 x 18 x 19
Single pendant without canopy, glass Ø22 H15 cm	E27 1 x max 70W	150 cm	1,100	2,100	26 x 26 x 47
Single pendant without canopy, glass Ø30 H19 cm	E27 1 x max 70W	150 cm	1,400	2,500	41 x 41 x 42
Single pendant without canopy, glass Ø38 H25 cm	E27 1 x max 70W	150 cm	2,400	4,200	41 x 41 x 42

Description	Bulb (not included)	Cable	Net weight kg	Gross weight kg	Package cm
Plate P43 Ø43 cm, glass Ø16-30-38 cm	E14 1x max 42W E27 2x max 70W	150 cm	6,440	11,000	51 x 51 x 14 / 2X 41 x 41 x 42

PARIGI[©] CIPOLLA ribbed glass

METAL STRUCTURE AVAILABLE: chrome

GLASS COLOUR AVAILABLE: transparent (01), pink (03), amber (05), green (06), sky-blue (07), fume (08), tobacco (16), ruby (17)

ERHAELTICHE AUSFÜHRUNGEN DER METALLTEILE: Chrom

ERHAELTICHE GLASFARBEN: transparent (01), rosa (03), bernstein (05), grün (06), hellblau (07), rauchfarben (08), tabak (16), rubinrot (17)

TABLE LAMP

CODE	TRANSPARENT	COLOURED	COLOURED FUME (08)
RLU1213	€ 314,00	€ 373,00	€ 373,00
RLUGIG1213	€ 513,00	€ 609,00	€ 670,00
RLUXXL1213	€ 817,00	€ 961,00	€ 1.058,00

WALL LAMP

CODE	TRANSPARENT	COLOURED	COLOURED FUME (08)
RAP1211.1L	€ 221,00	€ 264,00	€ 264,00

SINGLE PENDANT with canopy

CODE	TRANSPARENT	COLOURED	COLOURED FUME (08)
R1213.1L	€ 201,00	€ 239,00	€ 239,00
RMED1213.1L	€ 298,00	€ 356,00	€ 356,00
RGIG1213.1L	€ 352,00	€ 417,00	€ 457,00
RXXL1213.1L	€ 665,00	€ 793,00	€ 870,00

* **CODE without canopy** for compositions

CODE	TRANSPARENT	COLOURED	COLOURED FUME (08)
R1213	€ 177,00	€ 215,00	€ 215,00
RMED1213	€ 274,00	€ 332,00	€ 332,00
RGIG1213	€ 328,00	€ 393,00	€ 433,00
RXXL1213	€ 641,00	€ 769,00	€ 846,00

Composition example: **PLATE** STAINLESS POLISHED STEEL

CODE	TRANSPARENT	COLOURED	COLOURED FUME (08)
R1219MX.3L	€ 1.424,00	€ 1.655,00	€ 1.772,00



* TO CREATE **CUSTOM COMPOSITIONS**, USE THE PRICES **WITHOUT CANOPY** AND SELECT THE DESIRED STRUCTURE FROM PAGE 89 TO PAGE 105

- **TRANSPARENT ELECTRIC CABLE**

TRANSPARENTES KABEL

- **ONLY ON PRODUCTS GIG AND XXL IN FUME (08) COLOUR: 10% SURCHARGE ON THE PRICE OF THE COLOURED**
NUR FUER ARTIKEL GIG UND XXL IN FARBE RAUCHFARBEN (08): +10% AUFPREIS AUF "COLOURED" PREISE

- **AVAILABLE "LINO OLANDA" FABRIC SHADES FOR TABLE LAMPS: WHITE, CREAM, DOVE GRAY**
HOLLAND LEINEN LAMPENSCHIRME ERHAELTICH FUER TISCHLEUCHTEN: WEISS, CREME, GRAU-TAUBE

- **ON DEMAND: WITH UL COMPONENTS +10% in addition**
AUF ANFRAGE: MIT UL KOMPONENTEN + 10% Aufpreis

Description	Bulb (not included)	Cable	Net weight kg	Gross weight kg	Package cm
Table lamp Ø16 - H30 cm	E14 1 x max 40W	200 cm	0,520	1,000	26 x 26 x 47
Table lamp Ø30 - H53 cm	E27 1 x max 60W	200 cm	1,650	3,700	2X 41 x 41 x 42
Table lamp Ø38 - H63 cm	E27 1 x max 60W	200 cm	2,640	6,200	41 x 41 x 42 / 43 x 43 x 64

Description	Bulb (not included)	Cable	Net weight kg	Gross weight kg	Package cm
Wall lamp L15 P19 H23 cm	E14 1 x max 42W	/	0,450	0,900	38 x 18 x 19

Description	Bulb (not included)	Cable	Net weight kg	Gross weight kg	Package cm
Single pendant, glass Ø16 H12 cm - LAC10 canopy	E14 1 x max 42W	150 cm	0,450	0,900	38 x 18 x 19
Single pendant, glass Ø22 H15 cm - LAC10 canopy	E27 1 x max 70W	150 cm	1,100	2,100	26 x 26 x 47
Single pendant, glass Ø30 H19 cm - LAC10 canopy	E27 1 x max 70W	150 cm	1,400	2,500	41 x 41 x 42
Single pendant, glass Ø38 H25 cm - LAC10 canopy	E27 1 x max 70W	150 cm	2,400	4,200	41 x 41 x 42

Description	Bulb (not included)	Cable	Net weight kg	Gross weight kg	Package cm
Single pendant without canopy, glass Ø16 H12 cm	E14 1 x max 42W	150 cm	0,450	0,900	38 x 18 x 19
Single pendant without canopy, glass Ø22 H15 cm	E27 1 x max 70W	150 cm	1,100	2,100	26 x 26 x 47
Single pendant without canopy, glass Ø30 H19 cm	E27 1 x max 70W	150 cm	1,400	2,500	41 x 41 x 42
Single pendant without canopy, glass Ø38 H25 cm	E27 1 x max 70W	150 cm	2,400	4,200	41 x 41 x 42

Description	Bulb (not included)	Cable	Net weight kg	Gross weight kg	Package cm
Plate P43 Ø43 cm, glass Ø16-30-38 cm	E14 1x max 42W E27 2x max 70W	150 cm	6,440	11,000	51 x 51 x 14 / 2X 41 x 41 x 42

PARIGI[©] PALLA smooth glass

METAL STRUCTURE AVAILABLE: chrome

GLASS COLOUR AVAILABLE: transparent (01), pink (03), amber (05), green (06), sky-blue (07), fume (08), tobacco (16), ruby (17)

ERHAETLICHE AUSFUEHRUNGEN DER METALLTEILE: Chrom

ERHAETLICHE GLASFARBEN: transparent (01), rosa (03), bernstein (05), grün (06), hellblau (07), rauchfarben (08), tabak (16), rubinrot (17)

TABLE LAMP



CODE	TRANSPARENT	COLOURED	COLOURED FUME (08)
LU1203	€ 285,00	€ 340,00	€ 340,00
LUGIG1203	€ 467,00	€ 555,00	€ 611,00
LUXXL1203	€ 835,00	€ 994,00	€ 1.094,00

WALL LAMP



CODE	TRANSPARENT	COLOURED	COLOURED FUME (08)
AP1201.1L	€ 201,00	€ 240,00	€ 240,00

SINGLE PENDANT with canopy

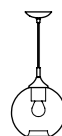

CODE	TRANSPARENT	COLOURED	COLOURED FUME (08)
1203.1L	€ 182,00	€ 219,00	€ 219,00
MED1203.1L	€ 271,00	€ 325,00	€ 325,00
GIG1203.1L	€ 319,00	€ 380,00	€ 416,00
XXL1203.1L	€ 661,00	€ 799,00	€ 877,00

* **CODE without canopy** for compositions

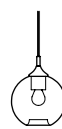

CODE	TRANSPARENT	COLOURED	COLOURED FUME (08)
1203	€ 158,00	€ 195,00	€ 195,00
MED1203	€ 247,00	€ 301,00	€ 301,00
GIG1203	€ 295,00	€ 356,00	€ 392,00
XXL1203	€ 637,00	€ 775,00	€ 853,00

Composition example: PLATE STAINLESS POLISHED STEEL



CODE	TRANSPARENT	COLOURED	COLOURED FUME (08)
1209MX.3L	€ 1.368,00	€ 1.604,00	€ 1.718,00



* TO CREATE **CUSTOM COMPOSITIONS**, USE THE PRICES **WITHOUT CANOPY** AND SELECT THE DESIRED STRUCTURE FROM PAGE 89 TO PAGE 105

- **TRANSPARENT ELECTRIC CABLE**

TRANSPARENTES KABEL

- **ONLY ON PRODUCTS GIG AND XXL IN FUME (08) COLOUR: 10% SURCHARGE ON THE PRICE OF THE COLOURED**
NUR FUER ARTIKEL GIG UND XXL IN FARBE RAUCHFARBEN (08): +10% AUFPREIS AUF "COLOURED" PREISE

- **AVAILABLE "LINO OLANDA" FABRIC SHADES FOR TABLE LAMPS: WHITE, CREAM, DOVE GRAY**
HOLLAND LEINEN LAMPENSCHIRME ERHAETLICH FUER TISCHLEUCHTEN: WEISS, CREME, GRAU-TAUBE

- **ON DEMAND: WITH UL COMPONENTS +10% in addition**
AUF ANFRAGE: MIT UL KOMPONENTEN + 10% Aufpreis

Description	Bulb (not included)	Cable	Net weight kg	Gross weight kg	Package cm
Table lamp Ø16 - H34 cm	E14 1 x max 40W	200 cm	0,520	1,000	26 x 26 x 47
Table lamp Ø28 - H58 cm	E27 1 x max 60W	200 cm	1,700	3,700	2X 41 x 41 x 42
Table lamp Ø38 - H78 cm	E27 1 x max 60W	200 cm	2,700	6,200	43 x 43 x 54 / 43 x 43 x 64

Description	Bulb (not included)	Cable	Net weight kg	Gross weight kg	Package cm
Wall lamp L15 P19 H25 cm	E14 1 x max 42W	/	0,490	0,900	38 x 18 x 19

Description	Bulb (not included)	Cable	Net weight kg	Gross weight kg	Package cm
Single pendant, glass Ø16 cm - LAC10 canopy	E14 1 x max 42W	150 cm	0,490	0,900	38 x 18 x 19
Single pendant, glass Ø22 cm - LAC10 canopy	E27 1 x max 70W	150 cm	1,200	2,200	26 x 26 x 47
Single pendant, glass Ø28 cm - LAC10 canopy	E27 1 x max 70W	150 cm	1,500	2,500	41 x 41 x 42
Single pendant, glass Ø38 cm - LAC10 canopy	E27 1 x max 70W	150 cm	2,400	4,300	43 x 43 x 54

Description	Bulb (not included)	Cable	Net weight kg	Gross weight kg	Package cm
Single pendant without canopy, glass Ø16 cm	E14 1 x max 42W	150 cm	0,490	0,900	38 x 18 x 19
Single pendant without canopy, glass Ø22 cm	E27 1 x max 70W	150 cm	1,200	2,200	26 x 26 x 47
Single pendant without canopy, glass Ø28 cm	E27 1 x max 70W	150 cm	1,500	2,500	41 x 41 x 42
Single pendant without canopy, glass Ø38 cm	E27 1 x max 70W	150 cm	2,400	4,300	43 x 43 x 54

Description	Bulb (not included)	Cable	Net weight kg	Gross weight kg	Package cm
Plate P43 Ø43 cm, glass Ø16-28-38 cm	E14 1x max 42W E27 2x max 70W	150 cm	6,940	11,000	51 x 51 x 14 / 41 x 41 x 42 / 50 x 50 x 12

PARIGI[©] PALLA ribbed glass

METAL STRUCTURE AVAILABLE: chrome

GLASS COLOUR AVAILABLE: transparent (01), pink (03), amber (05), green (06), sky-blue (07), fume (08), tobacco (16), ruby (17)

ERHAETLICHE AUSFÜHRUNGEN DER METALLTEILE: Chrom

ERHAETLICHE GLASFARBEN: transparent (01), rosa (03), bernstein (05), grün (06), hellblau (07), rauchfarben (08), tabak (16), rubinrot (17)

TABLE LAMP



CODE	TRANSPARENT	COLOURED	COLOURED FUME (08)
RLU1203	€ 314,00	€ 373,00	€ 373,00
RLUGIG1203	€ 513,00	€ 609,00	€ 670,00
RLUXXL1203	€ 918,00	€ 1.094,00	€ 1.204,00

WALL LAMP



CODE	TRANSPARENT	COLOURED	COLOURED FUME (08)
RAP1201.1L	€ 221,00	€ 264,00	€ 264,00

SINGLE PENDANT with canopy



CODE	TRANSPARENT	COLOURED	COLOURED FUME (08)
R1203.1L	€ 201,00	€ 239,00	€ 239,00
RMED1203.1L	€ 298,00	€ 356,00	€ 356,00
RGIG1203.1L	€ 352,00	€ 417,00	€ 457,00
RXXL1203.1L	€ 728,00	€ 879,00	€ 965,00

* **CODE without canopy** for compositions



CODE	TRANSPARENT	COLOURED	COLOURED FUME (08)
R1203	€ 177,00	€ 215,00	€ 215,00
RMED1203	€ 274,00	€ 332,00	€ 332,00
RGIG1203	€ 328,00	€ 393,00	€ 433,00
RXXL1203	€ 704,00	€ 855,00	€ 941,00

Composition example: PLATE STAINLESS POLISHED STEEL



CODE	TRANSPARENT	COLOURED	COLOURED FUME (08)
R1209MX.3L	€ 1.487,00	€ 1.741,00	€ 1.867,00



* TO CREATE **CUSTOM COMPOSITIONS**, USE THE PRICES **WITHOUT CANOPY** AND SELECT THE DESIRED STRUCTURE FROM PAGE 89 TO PAGE 105

- **TRANSPARENT ELECTRIC CABLE**

TRANSPARENTES KABEL

- **ONLY ON PRODUCTS GIG AND XXL IN FUME (08) COLOUR: 10% SURCHARGE ON THE PRICE OF THE COLOURED**
NUR FUER ARTIKEL GIG UND XXL IN FARBE RAUCHFARBEN (08): +10% AUFPREIS AUF "COLOURED" PREISE

- **AVAILABLE "LINO OLANDA" FABRIC SHADES FOR TABLE LAMPS: WHITE, CREAM, DOVE GRAY**
HOLLAND LEINEN LAMPENSCHIRME ERHAETLICH FUER TISCHLEUCHTEN: WEISS, CREME, GRAU-TAUBE

- **ON DEMAND: WITH UL COMPONENTS +10% in addition**
AUF ANFRAGE: MIT UL KOMPONENTEN + 10% Aufpreis

Description	Bulb (not included)	Cable	Net weight kg	Gross weight kg	Package cm
Table lamp Ø16 - H34 cm	E14 1 x max 40W	200 cm	0,520	1,000	26 x 26 x 47
Table lamp Ø28 - H58 cm	E27 1 x max 60W	200 cm	1,700	3,700	2X 41 x 41 x 42
Table lamp Ø38 - H78 cm	E27 1 x max 60W	200 cm	2,700	6,200	43 x 43 x 54 / 43 x 43 x 64

Description	Bulb (not included)	Cable	Net weight kg	Gross weight kg	Package cm
Wall lamp L15 P19 H25 cm	E14 1 x max 42W	/	0,490	0,900	38 x 18 x 19

Description	Bulb (not included)	Cable	Net weight kg	Gross weight kg	Package cm
Single pendant, glass Ø16 cm - LAC10 canopy	E14 1 x max 42W	150 cm	0,490	0,900	38 x 18 x 19
Single pendant, glass Ø22 cm - LAC10 canopy	E27 1 x max 70W	150 cm	1,200	2,200	31 x 31x 32
Single pendant, glass Ø28 cm - LAC10 canopy	E27 1 x max 70W	150 cm	1,500	2,500	41 x 41 x 42
Single pendant, glass Ø38 cm - LAC10 canopy	E27 1 x max 70W	150 cm	2,400	4,300	43 x 43 x 54

Description	Bulb (not included)	Cable	Net weight kg	Gross weight kg	Package cm
Single pendant without canopy, glass Ø16 cm	E14 1 x max 42W	150 cm	0,490	0,900	38 x 18 x 19
Single pendant without canopy, glass Ø22 cm	E27 1 x max 70W	150 cm	1,200	2,200	31 x 31x 32
Single pendant without canopy, glass Ø28 cm	E27 1 x max 70W	150 cm	1,500	2,500	41 x 41 x 42
Single pendant without canopy, glass Ø38 cm	E27 1 x max 70W	150 cm	2,400	4,300	43 x 43 x 54

Description	Bulb (not included)	Cable	Net weight kg	Gross weight kg	Package cm
Plate P43 Ø43 cm, glass Ø16-28-38 cm	E14 1x max 42W E27 2x max 70W	150 cm	6,940	11,000	51 x 51 x 14 / 41 x 41 x 42 / 50 x 50 x 12

METAL STRUCTURE AVAILABLE: chrome, brushed chrome, matt white, matt black

GLASS COLOUR AVAILABLE: transparent (01), pink (03), amber (05), green (06), sky-blue (07), fume (08), tobacco (16), ruby (17)

ERHAETLICHE AUSFÜHRUNGEN DER METALLTEILE: Chrom, Chrom gebürstet, Weiss matt, Schwarz Matt

ERHAETLICHE GLASFARBEN: transparent (01), rosa (03), bernstein (05), grün (06), hellblau (07), rauchfarben (08), tabak (16), rubinrot (17)

METAL FINISH FOR TABLE AND FLOOR LAMP AVAILABLE ONLY IN: chrome, satin gold, satin rose gold, satin black nickel (without surcharge)

AUSFÜHRUNGEN DER METALLTEILE für Tisch- und Stehleuchten: Chrom, gold satiniert, roségold satiniert, schwarz Nickel (ohne Aufpreis)

ON DEMAND:
AUF ANFRAGE:

WITH UL COMPONENTS
+10% in addition

MIT UL KOMPONENTEN
+ 10% Aufpreis

AVAILABLE WITH DALI
(ask for a quote)

ERHÄLTICH MIT DALI
(Angebot erfragen)

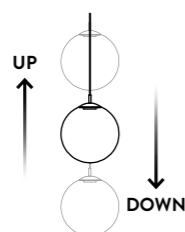

AVAILABLE WITH UP & DOWN SYSTEM (see price on page 105)

- AVAILABLE ONLY FOR PIT[®] XXL1583 MAX1583 (maximum weight 1,8 kg)
- CABLE AVAILABLE IN BLACK diam. 2,1 mm
- COAXIAL CABLE 0,24M2
- ADJUSTMENT: minimum length ca. 0,55 m / maximum length 1,90 m

ERHÄLTICH MIT UP&DOWN SYSTEM (siehe Preise Seite 105)

- NUR FUER PIT[®] XXL1583 MAX1583 ERHÄLTICH (max. Gewicht 1,8 kg)
- KABEL ERHÄLTICH IN SCHWARZ Durchm. 2,1 mm
- KOAXIALKABEL SCHWARZ 0,24M2
- HOEHENVERSTELLUNG: Mindestlaenge ca. 0,55 m - Max. Laenge 1,90 m

FLOOR LAMP

CODE	TRANSPARENT	COLOURED	COLOURED FUME (08)
LU1585.1L	€ 998,00	€ 1.122,00	€ 1.164,00

TABLE LAMP

CODE	TRANSPARENT	COLOURED	COLOURED FUME (08)
LU1580.1L	€ 491,00	€ 552,00	€ 552,00

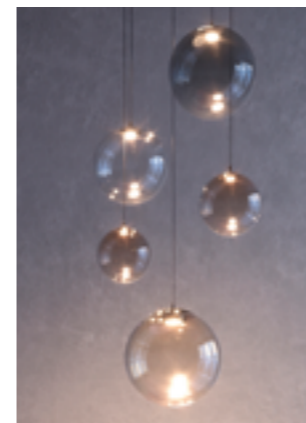

* TO CREATE **CUSTOM COMPOSITIONS**, USE THE PRICES **WITHOUT CANOPY**
AND SELECT THE DESIRED STRUCTURE FROM PAGE 89 TO PAGE 105

- **COAXIAL LOW VOLTAGE ELECTRIC CABLE IN TRANSPARENT OR BLACK**
NIEDERVOLT KOAXIALKABEL IN TRANSPARENT ODER SCHWARZ

- **SMALL SINGLE CANOPY AVAILABLE IN:** Satin gold, Satin rose gold, Satin black nickel - without surcharge
SMALL SINGLE CANOPY AVAILABLE IN: Satin gold, Satin rose gold, Satin black nickel - without surcharge

- **LAMPHOLDER AVAILABLE IN:** Satin gold, Satin rose gold (with surcharge +40,00 €) - Satin black nickel (without surcharge)
ERHAETLICHE LAMPENFASSUNGEN IN: Gold satiniert, Roségold satiniert (mit Aufschlag + 40,00 €) - Schwarz nickelsatiniert (ohne Aufpreis)

- **TRACKS AND PLATES AVAILABLE ONLY IN:** Chrome, Matt white, Matt black, Brushed chrome
SCHIENEN UND DECKENPLATTEN NUR ERHAETLICH IN: Chrom, Weiss matt, Schwarz matt, Chrom gebürstet

- **ALUMINUM LAMP HOLDER**
FASSUNG AUS ALUMINIUM

- **ONLY ON PRODUCTS GIG, XXL AND MAX IN FUME (08) COLOUR: 10% SURCHARGE ON THE PRICE OF THE COLOURED**
NUR FUER ARTIKEL GIG XXL UND MAX IN FARBE RAUCHFARBEN (08): +10% AUFPREIS AUF "COLOURED" PREISE

- **COMPATIBLE WITH**
KOMPATIBEL MIT **CASAMBI**

- **DRIVER INCLUDED**
TRAFO INBEGRIFFEN

- **DIMMABLE: YES (PHASE-CUT DIMMER TRIAC) - LED IS REPLACEABLE BY PROFESSIONAL**
DIMMBAR: (PHASENABSCHNITT) LED-PLATINE VON FACHMANN AUSTAUSCHBAR

LEDS AVAILABLE FOR PIT[®] / ERHAETLICHE LEDS FUER PIT[®] SERIE:

LED 1 x 6W DIMM - 11,2-12,8 V - 500 mA - CRI >90 - 866 Lm - 144 Lm/W - 3 Step MacAdam - **2700°K**
LED 1 x 6W DIMM - 11,2-12,8 V - 500 mA - CRI >90 - 866 Lm - 144 Lm/W - 3 Step MacAdam - **3000°K**

LED AVAILABLE FOR PIT[®] FLOOR LAMP / ERHAETLICHE LEDS FUER PIT[®] FLOOR LAMP SERIE:

LED 1 x 8,4W DIMM - 11,2-12,8 V - 700mA - CRI >90 - 1200 Lm - 144 Lm/W - 3 Step MacAdam - **2700°K**
LED 1 x 8,4W DIMM - 11,2-12,8 V - 700mA - CRI >90 - 1200 Lm - 144 Lm/W - 3 Step MacAdam - **3000°K**

LED AVAILABLE FOR PIT[®] CODE MAX1583 / ERHAETLICHE LEDS FUER PIT[®] CODE MAX1583 SERIE:

LED 1 x 8,4W DIMM - 22,4-24,8 V - 350 mA - CRI >90 - 1202 Lm - 144 Lm/W - 3 Step MacAdam - **2700°K**
LED 1 x 8,4W DIMM - 22,4-24,8 V - 350 mA - CRI >90 - 1202 Lm - 144 Lm/W - 3 Step MacAdam - **3000°K**

LUMEN INDICATED CORRESPONDS TO THE LUMINOUS INTENSITY AT THE ORIGIN OF THE LED BOARD
DIE ANGEgebenEN LUMEN ENTSPRECHEN DER LICHTINTENSITAET DER URSPRUENGLICHEN LED-PLATINE

ON DEMAND: PRODUCTS GIG1583 AND XXL1583 CAN BE REQUIRED WITH *8,4W LED with surcharge of +70.00 €
AUF ANFRAGE: BEI ARTIKEL GIG1583 UND XXL1583 KANN MAN *8,4W LEDS 8,4W einsetzen (+70,00 Aufpreis)

*LED 1 x 8,4W DIMM - 22,4-24,8 V - 350 mA CRI >90 1202 Lm - 144 Lm/W - 3 Step MacAdam - **2700°K** or **3000°K**

Description	LED (driver included)	Cable	Net weight kg	Gross weight kg	Package cm
Floor lamp Ø30 - H 175 cm with dimmer push button	LED 1 x 8,4W DIMM	200 cm	5,300	9,700	181 x 31 x 17 / 41 x 41 x 42

Description	LED (driver included)	Cable	Net weight kg	Gross weight kg	Package cm
Table lamp Ø22 - H 50 cm with dimmer push button	LED 1 x 6W DIMM	200 cm	1,800	2,600	2X 26 x 26 x 37

SINGLE PENDANT with canopy

CODE	TRANSPARENT	COLOURED	COLOURED FUME (08)
S1583.14.1L	€ 235,00	€ 285,00	€ 285,00
S1583.16.1L	€ 240,00	€ 290,00	€ 290,00
S1583.18.1L	€ 245,00	€ 295,00	€ 295,00
1583.1L	€ 269,00	€ 334,00	€ 334,00
GIG1583.1L	€ 294,00	€ 365,00	€ 400,00
XXL1583.1L	€ 392,00	€ 483,00	€ 529,00
MAX1583.1L	€ 648,00	€ 778,00	€ 854,00

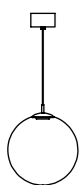

* CODE without canopy for compositions

CODE	TRANSPARENT	COLOURED	COLOURED FUME (08)
S1583.14	€ 211,00	€ 261,00	€ 261,00
S1583.16	€ 216,00	€ 266,00	€ 266,00
S1583.18	€ 221,00	€ 271,00	€ 271,00
1583	€ 245,00	€ 310,00	€ 310,00
GIG1583	€ 270,00	€ 341,00	€ 376,00
XXL1583	€ 368,00	€ 459,00	€ 505,00
MAX1583	€ 624,00	€ 754,00	€ 830,00



Composition example: TRACK STAINLESS POLISHED STEEL

CODE	TRANSPARENT	COLOURED	COLOURED FUME (08)
1587.120.3L	€ 988,00	€ 1.183,00	€ 1.183,00

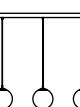

Composition example: PLATE STAINLESS POLISHED STEEL

CODE	TRANSPARENT	COLOURED	COLOURED FUME (08)
1589MX.43.3L	€ 1.161,00	€ 1.388,00	€ 1.469,00

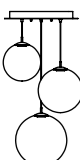

Description	LED (driver included)	Cable	Net weight kg	Gross weight kg	Package cm
Single pendant, glass Ø14 cm - PT9 canopy	LED 1 x 6W DIMM	200 cm	0,580	0,800	38 x 18 x 19
Single pendant, glass Ø16 cm - PT9 canopy	LED 1 x 6W DIMM	200 cm	0,640	0,940	38 x 18 x 19
Single pendant, glass Ø18 cm - PT9 canopy	LED 1 x 6W DIMM	200 cm	0,700	1,320	26 x 26 x 47
Single pendant, glass Ø22 cm - PT9 canopy	LED 1 x 6W DIMM	200 cm	0,750	1,500	26 x 26 x 47
Single pendant, glass Ø26 cm - PT9 canopy	LED 1 x 6W DIMM	200 cm	0,900	1,900	29 x 29 x 57
Single pendant, glass Ø30 cm - PT9 canopy	LED 1 x 6W DIMM	200 cm	1,100	2,300	41 x 41 x 42
Single pendant, glass Ø36 cm - PT9 canopy	LED 1 x 8,4W DIMM	200 cm	1,530	3,400	43 x 43 x 54

Description	LED (driver included)	Cable	Net weight kg	Gross weight kg	Package cm
Single pendant without canopy, glass Ø14 cm	LED 1 x 6W DIMM	200 cm	0,430	0,730	38 x 18 x 19
Single pendant without canopy, glass Ø16 cm	LED 1 x 6W DIMM	200 cm	0,490	0,790	38 x 18 x 19
Single pendant without canopy, glass Ø18 cm	LED 1 x 6W DIMM	200 cm	0,550	1,270	26 x 26 x 47
Single pendant without canopy, glass Ø22 cm	LED 1 x 6W DIMM	200 cm	0,750	1,500	26 x 26 x 47
Single pendant without canopy, glass Ø26 cm	LED 1 x 6W DIMM	200 cm	0,900	1,900	29 x 29 x 57
Single pendant without canopy, glass Ø30 cm	LED 1 x 6W DIMM	200 cm	1,100	2,300	41 x 41 x 42
Single pendant without canopy, glass Ø36 cm	LED 1 x 8,4W DIMM	200 cm	1,530	3,400	43 x 43 x 54

Description	LED (driver included)	Cable	Net weight kg	Gross weight kg	Package cm
Track AUF120 L120 cm, 3x glass Ø22 cm	LED 3 x 6W DIMM	200 cm	3,500	5,500	10 x 10 x 162 3X 26 x 26 x 47

Description	LED (driver included)	Cable	Net weight kg	Gross weight kg	Package cm
Plate P43 Ø43 cm, glass Ø22-26-30 cm	LED 3 x 6W DIMM	200 cm	4,800	8,500	51 x 51 x 14 / 26 x 26 x 37 29 x 29 x 47 / 41 x 41 x 42

REGULA[©][®]

EUIPO's registered community design

METAL STRUCTURE AVAILABLE: black carbon, champagne, french gold

GLASS COLOUR AVAILABLE: transparent (01), pink (03), amber (05), green (06), sky-blue (07), fume (08), tobacco (16), ruby (17)

ERHAELTICHE AUSFÜHRUNGEN DER METALLTEILE: black carbon, champagne, french gold

ERHAELTICHE GLASFARBEN: transparent (01), rosa (03), bernstein (05), grün (06), hellblau (07), rauchfarben (08), tabak (16), rubinrot (17)

ON DEMAND:
AUF ANFRAGE:

WITH UL COMPONENTS
+10% in addition

MIT UL KOMPONENTEN
+ 10% Aufpreis

AVAILABLE WITH DALI
(ask for a quote)

ERHÄLTICH MIT DALI
(Angebot erfragen)

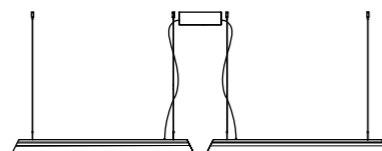

SYSTEM WITH SINGLE SHARED CANOPY

- AVAILABLE FOR REGULA[®] 1623.106.2L
- SINGLE POINT POWER SUPPLY

SYSTEM EINZELNE GEMEINSAMES BALDACHIN

- ERHÄLTICH FÜR REGULA[®] 1623.106.2L
- EINZELN STROMANSCHLUSS

WALL LAMP



CODE	TRANSPARENT	COLOURED	COLOURED FUME (08)
AP1621.30	€ 427,00	€ 471,00	€ 518,00
AP1621.46	€ 530,00	€ 609,00	€ 670,00

CEILING LAMP

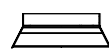

CODE	TRANSPARENT	COLOURED	COLOURED FUME (08)
1626.30	€ 427,00	€ 471,00	€ 518,00
1626.46	€ 530,00	€ 609,00	€ 670,00

HORIZONTAL SUSPENSION

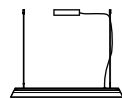

CODE	TRANSPARENT	COLOURED	COLOURED FUME (08)
1623.106	€ 1.350,00	€ 1.552,00	€ 1.708,00
1623.106.2L	€ 2.700,00	€ 3.104,00	€ 3.416,00



* TO CREATE **CUSTOM COMPOSITIONS**, USE THE PRICES **WITHOUT CANOPY**
AND SELECT THE DESIRED STRUCTURE FROM PAGE 89 TO PAGE 105

- **BLACK RUBBER OR TRANSPARENT ELECTRIC CABLE**
SCHWARZES KABEL ODER TRANSPARENTE

- **STRUCTURES AVAILABLE IN:** black carbon, champagne, french gold
RAHMEN ERHAELTICH IN: black carbon, champagne, french gold

- **METAL ALLOY FRAME**
RAHMEN AUS METALLEGIERUNG

- **COMPATIBLE WITH**
KOMPATIBEL MIT **CASAMBI**

- **DRIVER INCLUDED**
TRAFO INBEGRIFFEN

- **DIMMABLE: YES (PHASE-CUT DIMMER TRIAC) - LED IS REPLACEABLE BY PROFESSIONAL**
DIMMBAR: (PHASENABSCHNITT) LED-PLATINE VON FACHMANN AUSTAUSCHBAR

LEDS AVAILABLE FOR REGULA[®] / LEDS AVAILABLE FOR REGULA[®]:

APPLIQUE **AP1621.30** E PLAFONIERA **1626.30**/ WALL LAMP AP1621.30 AND CEILING LAMP **1626.30**:

LED 1 x 15W Dimmer Triac - 24 V - 625 mA - CRI Typ 95 - 2040 Lm - 136 Lm/W - 3 Step MacAdam - **2700°K**
LED 1 x 15W Dimmer Triac - 24 V - 625 mA - CRI Typ 95 - 2040 Lm - 136 Lm/W - 3 Step MacAdam - **3000°K**

WALL LAMP **AP1621.46** AND CEILING LAMP **1626.46**/ WALL LAMP **AP1621.46** AND CEILING LAMP **1626.46**:

LED 1 x 24W Dimmer Triac - 24 V - 750 mA - CRI Typ 95 - 3264 Lm - 136 Lm/W - 3 Step MacAdam - **2700°K**
LED 1 x 24W Dimmer Triac - 24 V - 750 mA - CRI Typ 95 - 3264 Lm - 136 Lm/W - 3 Step MacAdam - **3000°K**

SUSPENSION **1623.106**/ PENDELLEUCHTE **1623.106**:

LED 1 x 60W Dimmer Triac - 24 V - 2500 mA - CRI Typ 95 - 8160 Lm - 136 Lm/W - 3 Step MacAdam - **2700°K**
LED 1 x 60W Dimmer Triac - 24 V - 2500 mA - CRI Typ 95 - 8160 Lm - 136 Lm/W - 3 Step MacAdam - **3000°K**

LUMEN INDICATED CORRESPONDS TO THE LUMINOUS INTENSITY AT THE ORIGIN OF THE LED BOARD
DIE ANGEGEBENEN LUMEN ENTSPRECHEN DER LICHTINTENSITAET DER URSPRÜNGLICHEN LED-PLATINE

Description	LED (driver included)		Net weight kg	Gross weight kg	Package cm
Wall lamp L7 P11 H30 cm	LED 1 x 15W DIMM	/	1,300	2,300	42 x 34 x 14
Wall lamp L7 P11 H46 cm	LED 1 x 24W DIMM	/	1,900	3,100	57 x 34 x 14

Description	LED (driver included)		Net weight kg	Gross weight kg	Package cm
Ceiling lamp L30 P7 H11 cm	LED 1 x 15W DIMM	/	1,300	2,300	42 x 34 x 14
Ceiling lamp L46 P7 H11 cm	LED 1 x 24W DIMM	/	1,900	3,100	57 x 34 x 14

Description	LED (driver included)	Cable	Net weight kg	Gross weight kg	Package cm
Horizontal suspension L106 - P7 - H8 cm Canopy 24x10xH5 cm - 2x spacers	LED 1 x 60W DIMM	300 cm	3,800	6,300	133 x 34 x 14
2X Horizontal suspension L106 - P7 - H8 cm Canopy 24x10xH8 cm - 4x spacers	LED 2 x 60W DIMM	300 cm	7,600	12,600	2X 133 x 34 x 14

METAL STRUCTURE AVAILABLE: brushed brass (01), brushed bronze (02)

GLASS COLOUR AVAILABLE: transparent (01), amber (05), tobacco (16), satin white

ERHAETLICHE AUSFÜHRUNGEN DER METALLTEILE: gebürstetes Messing (01), gebürstete Bronze (02)

ERHAETLICHE GLASFARBEN: transparent (01), bernstein (05), grün (06), tabak (16), Satinweiß

METAL FINISH FOR CODE AP1490.2L AVAILABLE ONLY IN: satin gold, satin black nickel (without surcharge)

AUSFÜHRUNGEN DER METALLTEILE FUER AP1490.2L NUR ERHÄLTICH IN: gold säitiniert, schwarz Nickel (ohne Aufpreis)

WALL LAMP



CODE	TRANSPARENT	COLOURED
AP1491.1L	€ 217,00	€ 237,00

WALL LAMP



CODE	TRANSPARENT	COLOURED
AP1490.2L	€ 1.047,00	€ 1.088,00

CHANDELIER



CODE	TRANSPARENT	COLOURED
1493.4+4/8L	€ 1.231,00	€ 1.354,00
1493.6+6/12L	€ 1.927,00	€ 2.117,00
1493.8+8/16L	€ 2.607,00	€ 2.868,00

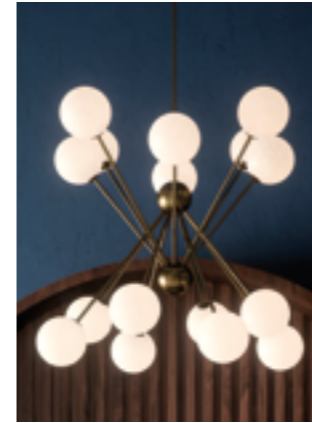

- BRASS METAL STRUCTURE

METALLGESTELL AUS MESSING

- ON DEMAND: THE CHANDELIER CAN BE MADE WITH CUSTOMIZED HEIGHT
(extending the metal pipe between the chandelier and the canopy)

AUF ANFRAGE: GESAMTHOEHE DES KRONLEUCHTERS KANN NACH MASS ANGEFERTIGT WERDEN
(Stab zwischen Kronleuchte und Baldachin kann nach Wunsch verlängert werden)

- ON DEMAND: WITH UL COMPONENTS +10% in addition

AUF ANFRAGE: MIT UL KOMPONENTEN + 10% Aufpreis

LED AVAILABLE FOR AP1490.2L / ERHAETLICHE LEDS FUER AP1490.2L:

LED 10W - 915 Lm - 92 Lm/W - 230V - 3000°K

LUMEN INDICATED CORRESPONDS TO THE LUMINOUS INTENSITY AT THE ORIGIN OF THE LED BOARD
DIE ANGEGBENEN LUMEN ENTSPRECHEN DER LICHTINTENSITAET DER URSPRÜNGLICHEN LED-PLATINE

Description	Bulb (not included)	Cable	Net weight kg	Gross weight kg	Package cm
Floor lamp L24 - P66 - H185 cm 2 bulbs	E14 1 x max 42W LED 1 x 10W (integrated)	200 cm	8,600	11,850	185 x 70 x 35

Description	Bulb (not included)	Cable	Net weight kg	Gross weight kg	Package cm
Wall lamp L92 P156 H110 cm - 2 bulbs	E14 1 x max 42W LED 1 x 10W (integrated)	/	3,750	8,750	180 x 30 x 15 / 26 x 26 x 27

Description	Bulb (not included)	Cable	Net weight kg	Gross weight kg	Package cm
Chandelier Ø60 - H72 cm - 8 bulbs	E14 8 x max 42W	/	3,700	6,700	51 x 51 x 60
Chandelier Ø80 - H98 cm - 12 bulbs	E14 12 x max 42W	/	6,500	11,500	71 x 71 x 76
Chandelier Ø102 - H114 cm - 16 bulbs	E14 16 x max 42W	/	8,200	14,200	100 x 100 x 90

VISIBLE METAL STRUCTURE AVAILABLE: chrome

GLASS COLOUR AVAILABLE: transparent (01), pink (03), amber (05), green (06), sky-blue (07), fume (08), tobacco (16), ruby (17)

METALLIC GLASS COLOUR AVAILABLE: rose gold, titanium

ERHAETLICHE AUSFUEHRUNGEN DER SICHTBARE METALLTEILE: Chrom

ERHAETLICHE GLASFARBEN: transparent (01), rosa (03), bernstein (05), grün (06), hellblau (07), rauchfarben (08), tabak (16), rubinrot (17)

ERHAETLICHE METALLISCHE GLASFARBEN: Roségold, Titanium

WALL LAMP

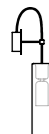

CODE	TRANSPARENT	COLOURED	COLOURED FUME (08)	METALLIC GLASS
API381.1L	€ 256,00	€ 298,00	€ 298,00	€ 372,00

SINGLE PENDANT with canopy

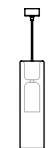

CODE	TRANSPARENT	COLOURED	COLOURED FUME (08)	METALLIC GLASS
1383.1L	€ 235,00	€ 277,00	€ 277,00	€ 351,00
GIG1383.1L	€ 360,00	€ 409,00	€ 448,00	€ 494,00

* CODE without canopy for compositions

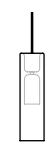

CODE	TRANSPARENT	COLOURED	COLOURED FUME (08)	METALLIC GLASS
1383	€ 211,00	€ 253,00	€ 253,00	€ 327,00
GIG1383	€ 336,00	€ 385,00	€ 424,00	€ 470,00

Composition example: MULTIPLE SUSPENSION LAMP



CODE	TRANSPARENT	COLOURED	COLOURED FUME (08)	METALLIC GLASS
1383.2L	€ 501,00	€ 585,00	€ 585,00	€ 733,00
GIG1383.2L	€ 751,00	€ 849,00	€ 927,00	€ 1.019,00

Composition example: MULTIPLE SUSPENSION LAMP

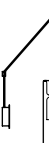

CODE	TRANSPARENT	COLOURED	COLOURED FUME (08)	METALLIC GLASS
1385.1L	on demand	on demand	on demand	on demand
1385.3L	on demand	on demand	on demand	on demand

Composition example: TRACK STAINLESS POLISHED STEEL

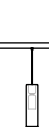

CODE	TRANSPARENT	COLOURED	COLOURED FUME (08)	METALLIC GLASS
1387.90.3L	€ 850,00	€ 976,00	€ 976,00	€ 1.198,00
GIG1387.90.3L	€ 1.225,00	€ 1.372,00	€ 1.489,00	€ 1.627,00

Composition example: PLATE STAINLESS POLISHED STEEL



CODE	TRANSPARENT	COLOURED	COLOURED FUME (08)	METALLIC GLASS
1389.6L	€ 1.484,00	€ 1.736,00	€ 1.736,00	€ 2.180,00
GIG1389.3L	€ 1.226,00	€ 1.373,00	€ 1.490,00	€ 1.628,00



* TO CREATE **CUSTOM COMPOSITIONS**, USE THE PRICES **WITHOUT CANOPY** AND SELECT THE DESIRED STRUCTURE FROM PAGE 89 TO PAGE 105

- **TRANSPARENT ELECTRIC CABLE, ON DEMAND: BLACK TEXTILE**, without surcharge
TRANSPARENTES KABEL, AUF ANFRAGE: SCHWARZES TEXTILKABEL, ohne aufpreis

- **METAL ROD TUBE, ON DEMAND: MATT WHITE OR MATT BLACK**, with surcharge +32,00 €
METALLSTANGE ROHR, AUF ANFRAGE: WEISS MATT OR SCHWARZ MATT, mit Aufschlag +32,00 €

- **ONLY ON PRODUCT GIG IN FUME (08) COLOUR: 10% SURCHARGE ON THE PRICE OF THE COLOURED**
NUR FUER ARTIKEL GIG IN FARBE RAUCHFARBEN (08): +10% AUFPREIS AUF "COLOURED" PREISE

- **ON DEMAND: WITH UL COMPONENTS +10% in addition**
AUF ANFRAGE: MIT UL KOMPONENTEN + 10% Aufpreis

Description	Bulb (not included)	Cable	Net weight kg	Gross weight kg	Package cm
Wall lamp L8 P16 H50 cm - with API0 structure	G9 1 x max 33W	50 cm	0,970	1,520	55 x 21 x 19

Description	Bulb (not included)	Cable	Net weight kg	Gross weight kg	Package cm
Single pendant, glass Ø8 H30 cm - ECL6 canopy	G9 1 x max 33W	150 cm	0,800	1,300	55 x 21 x 19
Single pendant, glass Ø10 H37 cm - ECL6 canopy	E27 1 x max 70W	150 cm	1,500	2,200	26 x 26 x 47

Description	Bulb (not included)	Cable	Net weight kg	Gross weight kg	Package cm
Single pendant without canopy, glass Ø8 H30 cm	G9 1 x max 33W	150 cm	0,800	1,300	55 x 21 x 19
Single pendant without canopy, glass Ø10 H37 cm	E27 1 x max 70W	150 cm	1,500	2,200	26 x 26 x 47

Description	Bulb (not included)	Cable	Net weight kg	Gross weight kg	Package cm
Susp. composed of 2 glasses Ø8 cm - ECL9,5 canopy - 2x WS5	G9 2 x max 33W	250 cm	1,500	2,600	2X 55 x 21 x 19
Susp. composed of 2 glasses Ø10 cm - ECL9,5 canopy - 2x WS5	G9 2 x max 33W	250 cm	3,200	4,200	2X 26 x 26 x 47

Description	Bulb (not included)	Cable	Net weight kg	Gross weight kg	Package cm
Suspension composed of 1 glass Ø8 cm with WS4	G9 1 x max 33W	250 cm	2,400	3,900	55 x 21 x 19
Suspension composed of 3 glasses Ø8 cm with WS4	G9 3 x max 33W	250 cm	4,000	6,500	41 x 41 x 42

Description	Bulb (not included)	Cable	Net weight kg	Gross weight kg	Package cm
Track AUF90 L90 cm, 3x glass Ø8 H30 cm	G9 3 x max 33W	150 cm	3,960	7,660	10 x 10 x 162 / 41 x 41 x 42
Track AUF90 L90 cm, 3x glass Ø10 H37 cm	E27 3 x max 70W	150 cm	6,060	10,960	10 x 10 x 162 / 3X 26 x 26 x 47

Description	Bulb (not included)	Cable	Net weight kg	Gross weight kg	Package cm
Plate P27 Ø27 cm, 6x glass Ø8 H30 cm	G9 6 x max 33W	150 cm	5,245	8,000	33 x 33 x 24 / 41 x 41 x 42
Plate P27 Ø27 cm, 3x glass Ø10 H37 cm	E27 3 x max 70W	150 cm	5,600	6,800	33 x 33 x 24 / 3X 26 x 26 x 47

METAL STRUCTURE AVAILABLE: satin gold, satin black nickel

GLASS COLOUR AVAILABLE: transparent (01), pink (03), amber (05), green (06), sky-blue (07), fume (08), tobacco (16), ruby (17)

ERHAELTICHE AUSFÜHRUNGEN DER METALLTEILE: Gold satiniert, Schwarzes nikel satiniert

ERHAELTICHE GLASFARBEN: transparent (01), rosa (03), bernstein (05), grün (06), hellblau (07), rauchfarben (08), tabak (16), rubinrot (17)

ON DEMAND:
AUF ANFRAGE:

WITH UL COMPONENTS
+10% in addition

MIT UL KOMPONENTEN
+ 10% Aufpreis

AVAILABLE WITH DALI
(ask for a quote)

ERHÄLTICH MIT DALI
(Angebot erfragen)

PRODUCT 1604 (PALMA) CAN BE MADE WITH METAL ROD LONG 60 or 80 cm INSTEAD OF 45 cm (CUSTOMIZED HEIGHT MAX of the metal pipe between the chandelier and the canopy: 1,2 mt)

ARTIKEL 1604 (PALMA) IST AUF ANFRAGE MIT EINEM FESTEN STAB BIS MAX. 1,20 ERHÄLTICH (STANDARDLÄNGE 45 CM)



* TO CREATE **CUSTOM COMPOSITIONS**, USE THE PRICES **WITHOUT CANOPY** AND SELECT THE DESIRED STRUCTURE FROM PAGE 89 TO PAGE 105

- **COAXIAL LOW VOLTAGE ELECTRIC CABLE IN TRANSPARENT OR BLACK**
NIEDERVOLT KOAXIALKABEL IN TRANSPARENT ODER SCHWARZ

- **SINGLE STRUCTURE AVAILABLE IN: Satin gold, Satin black nickel - without surcharge**
FASSUNG ERHAELTICH IN: Gold satiniert, Schwarzes nikel satiniert - ohne aufpreis

- **TRACKS AND PLATES AVAILABLE ONLY IN: Chrome, Matt white, Matt black, Brushed chrome**
SCHIENEN UND DECKENPLATTEN NUR ERHAELTICH IN: Chrom, Weiss matt, Schwarz matt, Chrom gebürstet

- **ONLY ON PRODUCT 1604.1L (PALMA) IN FUME (08) COLOUR: 10% SURCHARGE ON THE PRICE OF THE COLOURED**
NUR FUER ARTIKEL 1604.1L (PALMA) IN FARBE RAUCHFARBEN (08): +10% AUFPREIS AUF "COLOURED" PREISE

- **COMPATIBLE WITH CASAMBI**
KOMPATIBEL MIT

- **DRIVER INCLUDED**
TRAFO INBEGRIFFEN

- **DIMMABLE: YES (PHASE-CUT DIMMER TRIAC) - LED IS REPLACEABLE BY PROFESSIONAL**
DIMMBAR: (PHASENABSCHNITT) LED-PLATINE VON FACHMANN AUSTAUSCHBAR

LEDS AVAILABLE FOR VEGETAL® / LERHAELTICHE LEDS FUER VEGETAL® SERIE:

LED 1 x 4,2W DIMM - 11,2-12,8V - 350 mA - 460-500 Lm - 110-120 Lm/W - **2700°K**
LED 1 x 4,2W DIMM - 11,2-12,8V - 350 mA - 460-500 Lm - 110-120 Lm/W - **3000°K**

LEDS AVAILABLE FOR VEGETAL® **1604.1L (PALMA)** / LERHAELTICHE LEDS FUER VEGETAL® **1604.1L (PALMA)** SERIE:

LED 1 x 6W DIMM - 11,2-12,8 V - 500 mA - CRI >90 - 866 Lm - 144 Lm/W - 3 Step MacAdam - **2700°K**
LED 1 x 6W DIMM - 11,2-12,8 V - 500 mA - CRI >90 - 866 Lm - 144 Lm/W - 3 Step MacAdam - **3000°K**

LUMEN INDICATED CORRESPONDS TO THE LUMINOUS INTENSITY AT THE ORIGIN OF THE LED BOARD
DIE ANGEGBENEN LUMEN ENTSPRECHEN DER LICHTINTENSITAET DER URSPRÜNGLICHEN LED-PLATINE

SINGLE PENDANT with canopy

CODE	TRANSPARENT	COLOURED	COLOURED FUME (08)
1601.1L (CALATHEA)	€ 287,00	€ 330,00	€ 330,00
1602.1L (FICUS)	€ 275,00	€ 317,00	€ 317,00
1603.1L (PILEA)	€ 298,00	€ 340,00	€ 340,00
1604.1L (PALMA)	€ 638,00	€ 709,00	€ 778,00

Description	LED (driver included)	Cable	Net weight kg	Gross weight kg	Package cm
Single pendant, glass Ø12 cm Canopy VE7,5	LED 1 x 4,2W DIMM	200 cm	0,491	0,991	23 x 23 x 24
Single pendant, glass Ø12 cm Canopy VE7,5	LED 1 x 4,2W DIMM	200 cm	0,457	0,957	23 x 23 x 24
Single pendant, glass Ø12 cm Canopy VE7,5	LED 1 x 4,2W DIMM	200 cm	0,463	0,963	23 x 23 x 24
Single pendant with metal rod, glass Ø26 cm, H100 cm PT9 canopy	LED 1 x 6W DIMM	/	1,750	3,120	32 x 41 x 3 29 x 29 x 47 16 x 17 x 71

* **CODE without canopy** for compositions

CODE	TRANSPARENT	COLOURED	COLOURED FUME (08)
 1601 (CALATHEA)	€ 263,00	€ 306,00	€ 306,00
 1602 (FICUS)	€ 251,00	€ 293,00	€ 293,00
 1603 (PILEA)	€ 274,00	€ 316,00	€ 316,00
 1604 (PALMA)	€ 614,00	€ 685,00	€ 754,00

Description	LED (driver included)	Cable	Net weight kg	Gross weight kg	Package cm
Single pendant without canopy, glass Ø12 cm	LED 1 x 4,2W DIMM	200 cm	0,291	0,831	23 x 23 x 24
Single pendant without canopy, glass Ø12 cm	LED 1 x 4,2W DIMM	200 cm	0,257	0,979	23 x 23 x 24
Single pendant without canopy, glass Ø12 cm	LED 1 x 4,2W DIMM	200 cm	0,263	0,803	23 x 23 x 24
Single pendant with metal rod without canopy glass Ø26, H95 cm	LED 1 x 6W DIMM	/	1,550	2,960	32 x 41 x 3 29 x 29 x 47 16 x 17 x 71

Composition example: TRACK STAINLESS POLISHED STEEL

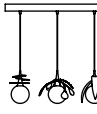
CODE	TRANSPARENT	COLOURED	COLOURED FUME (08)
 1607MX.90.3L	€ 1.005,00	€ 1.132,00	€ 1.132,00

Description	LED (driver included)	Cable	Net weight kg	Gross weight kg	Package cm
Track AUF90 L90 cm, 3x glass Ø12 cm	LED 3 x 4,2W DIMM	200 cm	2,911	7,101	10 x 10 x 162 3X 23 x 23 x 24

Composition example: PLATE STAINLESS POLISHED STEEL

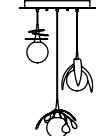
CODE	TRANSPARENT	COLOURED	COLOURED FUME (08)
 1609MX.43.3L	€ 1.066,00	€ 1.193,00	€ 1.193,00

Description	LED (driver included)	Cable	Net weight kg	Gross weight kg	Package cm
Plate P43 Ø43 cm, 3x glass Ø12 cm	LED 3 x 4,2W DIMM	200 cm	3,831	6,051	51 x 51 x 14 3X 23 x 23 x 24

Composition example: PLATE STAINLESS POLISHED STEEL

CODE	TRANSPARENT	COLOURED	COLOURED FUME (08)
 1609MX.40X130.7L	€ 2.401,00	€ 2.697,00	€ 2.697,00

Description	LED (driver included)	Cable	Net weight kg	Gross weight kg	Package cm
Plate P40X130 40x130 cm, 7x glass Ø12 cm 3x FICUS, 2x CALATHEA, 2x PILEA	LED 7 x 4,2W DIMM	200 cm	13,880	24,980	156 x 56 x 16,5 7X 23 x 23 x 24

VISIBLE METAL STRUCTURE AVAILABLE: chrome, brushed chrome, matt white, matt black

GLASS COLOUR AVAILABLE: transparent (01), pink (03), amber (05), green (06), sky-blue (07), fume (08), tobacco (16), ruby (17)

METALLIC GLASS COLOUR AVAILABLE: bronze, black, gold, rose gold, petrolium, titanium, lapsus

ERHAETLICHE AUSFÜHRUNGEN DER SICHTBARE METALLTEILE: Chrom, Chrom gebürstet, Weiss matt, Schwarz Matt

ERHAETLICHE GLASFARBEN: transparent (01), rosa (03), bernstein (05), grün (06), hellblau (07), rauchfarben (08), tabak (16), rubinrot (17)

ERHAETLICHE METALLISCHE GLASFARBEN: Bronze, Schwarz, Gold, Roségold, Petroleum, Titanium, Lapsus

TABLE LAMP without lampshade



CODE	TRANSPARENT	COLOURED	COLOURED FUME (08)	BRONZE / BLACK / PETROLIUM / STEEL	GOLD / ROSE GOLD / TITANIUM / LAPSUS
LU1300	€ 400,00	€ 474,00	€ 474,00	€ 507,00	€ 542,00
LUGIG1300	€ 558,00	€ 677,00	€ 745,00	€ 721,00	€ 770,00
LUXXL1300	€ 885,00	€ 1.076,00	€ 1.184,00	€ 1.107,00	€ 1.182,00

TABLE LAMP with lampshade

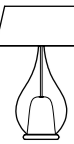

CODE	TRANSPARENT	COLOURED	COLOURED FUME (08)	BRONZE / BLACK / PETROLIUM / STEEL	GOLD / ROSE GOLD / TITANIUM / LAPSUS
LU1303	€ 520,00	€ 596,00	€ 596,00	€ 626,00	€ 668,00
LUGIG1303	€ 762,00	€ 877,00	€ 965,00	€ 924,00	€ 987,00
LUXXL1303	€ 1.125,00	€ 1.315,00	€ 1.447,00	€ 1.347,00	€ 1.438,00

WALL LAMP

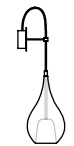

CODE	TRANSPARENT	COLOURED	COLOURED FUME (08)	BRONZE / BLACK / PETROLIUM / STEEL	GOLD / ROSE GOLD / TITANIUM / LAPSUS
AP1301.1L	€ 332,00	€ 406,00	€ 406,00	€ 439,00	€ 466,00

SINGLE PENDANT with canopy



CODE	TRANSPARENT	COLOURED	COLOURED FUME (08)	BRONZE / BLACK / PETROLIUM / STEEL	GOLD / ROSE GOLD / TITANIUM / LAPSUS
1303.1L	€ 311,00	€ 385,00	€ 385,00	€ 418,00	€ 445,00
GIG1303.1L	€ 456,00	€ 571,00	€ 626,00	€ 620,00	€ 660,00
XXL1303.1L	€ 767,00	€ 957,00	€ 1.051,00	€ 987,00	€ 1.052,00

* CODE without canopy for compositions



CODE	TRANSPARENT	COLOURED	COLOURED FUME (08)	BRONZE / BLACK / PETROLIUM / STEEL	GOLD / ROSE GOLD / TITANIUM / LAPSUS
1303	€ 287,00	€ 361,00	€ 361,00	€ 394,00	€ 421,00
GIG1303	€ 432,00	€ 547,00	€ 602,00	€ 596,00	€ 636,00
XXL1303	€ 743,00	€ 933,00	€ 1.027,00	€ 963,00	€ 1.028,00



* TO CREATE **CUSTOM COMPOSITIONS**, USE THE PRICES **WITHOUT CANOPY** AND SELECT THE DESIRED STRUCTURE FROM PAGE 89 TO PAGE 105

- **TRANSPARENT ELECTRIC CABLE, ON DEMAND: BLACK TEXTILE**, without surcharge
TRANSPARENTES KABEL, AUF ANFRAGE: SCHWARZES TEXTILKABEL, ohne aufpreis

- **METAL ROD TUBE, ON DEMAND: MATT WHITE OR MATT BLACK**, with surcharge +32,00 €
METALLSTANGE ROHR, AUF ANFRAGE: WEISS MATT OR SCHWARZ MATT, mit Aufschlag +32,00 €

- **ON DEMAND: HANGING LAMPS AND WALL LAMPS WITH E14 CAN BE MADE WITH G9**, without surcharge
AUF ANFRAGE: HÄNGELEUCHTE UND WANDLEUCHTE MIT E14 IST MIT G9 ERHÄLTlich, ohne Aufpreis

- **ONLY ON PRODUCTS GIG XXL AND MAX IN FUME (08) COLOUR: 10% SURCHARGE ON THE PRICE OF THE COLOURED**
NUR FUER ARTIKEL GIG XXL UND MAX IN FARBE RAUCHFARBEN (08): +10% AUFPREIS AUF "COLOURED" PREISE

- **ON DEMAND: WITH UL COMPONENTS +10% in addition**
AUF ANFRAGE: MIT UL KOMPONENTEN + 10% Aufpreis

LED AVAILABLE FOR TABLE LAMPS WITH SHADE / LED ERHÄLTlich FÜR TISCHLEUCHTE MIT LAMPENSCHIRM:
LED 4,3W 350 LUMEN 3.000K

LUMEN INDICATED CORRESPONDS TO THE LUMINOUS INTENSITY AT THE ORIGIN OF THE LED BOARD
DIE ANGEgebenEN LUMEN ENTSPRECHEN DER LICHTINTENSITÄT DER URSPRÜNGlichen LED-PLATINE

Description	Bulb (not included)	Cable	Net weight kg	Gross weight kg	Package cm
Table lamp Ø16 - H33 cm	E14 1x max 40W	200 cm	0,800	1,700	26 x 26 x 47
Table lamp Ø22 - H43 cm	E27 1x max 60W	200 cm	1,620	2,500	29 x 29 x 57
Table lamp Ø30 - H58 cm	E27 1x max 60W	200 cm	2,780	4,300	39 x 39 x 67

Description	Bulb (not included)	Cable	Net weight kg	Gross weight kg	Package cm
Table lamp Ø25 - H43 cm with lampshade	E14 1x max 40W LED 1x 4,3W included	200 cm	1,100	2,000	29 x 29 x 57
Table lamp Ø40 - H58 cm with lampshade	E27 1x max 60W LED 1x 4,3W included	200 cm	1,920	3,800	29 x 29 x 57 / 41 x 41 x 32
Table lamp Ø50 - H78 cm with lampshade	E27 1x max 60W LED 1x 4,3W included	200 cm	3,435	6,500	39 x 39 x 67 / 51 x 51 x 50

Description	Bulb (not included)	Cable	Net weight kg	Gross weight kg	Package cm
Wall lamp L16 P20 H58 cm	E14 1x max 60W	50 cm	0,875	1,300	26 x 26 x 47

Description	Bulb (not included)	Cable	Net weight kg	Gross weight kg	Package cm
Single pendant, glass Ø16 H28 cm - LAC10 canopy	E14 1x max 60W	150 cm	0,790	1,300	26 x 26 x 47
Single pendant, glass Ø22 H38 cm - LAC10 canopy	E27 1x max 105W	150 cm	1,510	2,400	29 x 29 x 57
Single pendant, glass Ø30 H53 cm - LAC10 canopy	E27 1x max 105W	150 cm	2,500	4,300	39 x 39 x 67

Description	Bulb (not included)	Cable	Net weight kg	Gross weight kg	Package cm
Single pendant without canopy, glass Ø16 H28 cm	E14 1x max 60W	150 cm	0,790	1,300	26 x 26 x 47
Single pendant without canopy, glass Ø22 H38 cm	E27 1x max 105W	150 cm	1,510	2,400	29 x 29 x 57
Single pendant without canopy, glass Ø30 H53 cm	E27 1x max 105W	150 cm	2,500	4,300	39 x 39 x 67

Composition example: MULTIPLE SUSPENSION LAMP

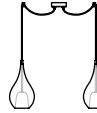

CODE	TRANSPARENT	COLOURED	COLOURED FUME (08)	BRONZE / BLACK / PETROLIUM / STEEL	GOLD / ROSE GOLD / TITANIUM / LAPSUS
1303.2L	€ 653,00	€ 801,00	€ 801,00	€ 867,00	€ 921,00
1303.3L	€ 966,00	€ 1.188,00	€ 1.188,00	€ 1.287,00	€ 1.368,00
GIG1303.2L	€ 943,00	€ 1.173,00	€ 1.283,00	€ 1.271,00	€ 1.351,00
XXL1303.2L	€ 1.565,00	€ 1.945,00	€ 2.133,00	€ 2.005,00	€ 2.135,00

Composition example: TRACK STAINLESS POLISHED STEEL

CODE	TRANSPARENT	COLOURED	COLOURED FUME (08)	BRONZE / BLACK / PETROLIUM / STEEL	GOLD / ROSE GOLD / TITANIUM / LAPSUS
1307.90.3L	€ 1.078,00	€ 1.300,00	€ 1.300,00	€ 1.399,00	€ 1.480,00
GIG1307.120.3L	€ 1.549,00	€ 1.894,00	€ 2.059,00	€ 2.041,00	€ 2.161,00

Composition example: PLATE STAINLESS POLISHED STEEL

CODE	TRANSPARENT	COLOURED	COLOURED FUME (08)	BRONZE / BLACK / PETROLIUM / STEEL	GOLD / ROSE GOLD / TITANIUM / LAPSUS
1309MX.3L	€ 1.740,00	€ 2.119,00	€ 2.268,00	€ 2.231,00	€ 2.363,00

Description	Bulb (not included)	Cable	Net weight kg	Gross weight kg	Package cm
Susp. composed of 2 glasses Ø16 cm - ECL9,5 canopy - 2x WS5	E14 2 x max 60W	250 cm	1,530	2,500	2X 26 x 26 x 47
Susp. composed of 3 glasses Ø16 cm - ECL9,5 canopy - 3x WS5	E14 3 x max 60W	250 cm	2,250	3,600	41 x 41 x 42
Susp. composed of 2 glasses Ø22 cm - ECL9,5 canopy - 2x WS5	E27 2 x max 105W	250 cm	2,810	4,660	2X 29 x 29 x 57
Susp. composed of 2 glasses Ø30 cm - ECL9,5 canopy - 2x WS5	E27 2 x max 105W	250 cm	4,800	8,600	2X 39 x 39 x 67

Description	Bulb (not included)	Cable	Net weight kg	Gross weight kg	Package cm
Track AUF90 L90 cm, 3x glass Ø16 H28 cm	E14 3 x max 60W	150 cm	3,960	7,200	10 x 10 x 162 / 41 x 41 x 42
Track AUF120 L120 cm, 3x glass Ø22 H38 cm	E27 3 x max 105W	150 cm	5,590	9,400	10 x 10 x 162 / 3X 29 x 29 x 57

Description	Bulb (not included)	Cable	Net weight kg	Gross weight kg	Package cm
Plate P43 Ø43 cm, glass Ø16-22-30 cm	E14 1 x max 60W E27 2 x max 105W	150 cm	6,480	14,700	51 x 51 x 14 / 39 x 39 x 67 29 x 29 x 57 / 26 x 26 x 47

VISIBLE METAL STRUCTURE AVAILABLE: chrome, brushed chrome, matt white, matt black

GLASS COLOUR AVAILABLE: transparent (01), pink (03), amber (05), green (06), sky-blue (07), fume (08), tobacco (16), ruby (17)

METALLIC GLASS COLOUR AVAILABLE: bronze, black, rose gold

ERHAELTICHE AUSFÜHRUNGEN DER SICHTBARE METALLTEILE: Chrom, Chrom gebürstet, Weiss matt, Schwarz Matt

ERHAELTICHE GLASFARBEN: transparent (01), rosa (03), bernstein (05), grün (06), hellblau (07), rauchfarben (08), tabak (16), rubinrot (17)

ERHAELTICHE METALLISCHE GLASFARBEN: Bronze, Schwarz, Roségold

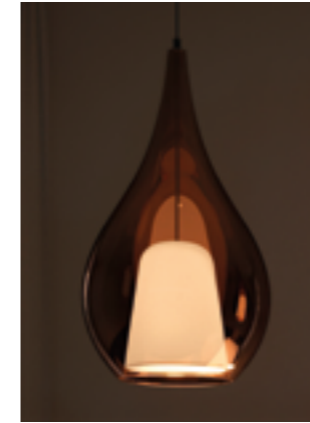

* TO CREATE **CUSTOM COMPOSITIONS**, USE THE PRICES **WITHOUT CANOPY** AND SELECT THE DESIRED STRUCTURE FROM PAGE 89 TO PAGE 105

- **BLACK OR TRANSPARENT ELECTRIC CABLE**
SCHWARZES KABEL ODER TRANSPARENTE

- **METAL ROD TUBE, ON DEMAND: MATT WHITE OR MATT BLACK, with surcharge +32,00 €**
METALLSTANGE ROHR, AUF ANFRAGE: WEISS MATT OR SCHWARZ MATT, mit Aufschlag +32,00 €

- **ON PRODUCTS MAX IN FUME (08) COLOUR: 10% SURCHARGE ON THE PRICE OF THE COLOURED**
FUER ARTIKEL MAX IN FARBE RAUCHFARBEN (08): +10% AUFPREIS AUF "COLOURED" PREISE

- **ON DEMAND: WITH UL COMPONENTS +10% in addition**
AUF ANFRAGE: MIT UL KOMPONENTEN + 10% Aufpreis



WE RECOMMEND: LED BULB E27 LED 25w 2250 lm Ø140 mm (NOT INCLUDED)
EMPFEHLUNG: LED-GLÜHBIRNE E27 LED 25w 2250 lm Ø140 mm (NICHT ENTHALTEN)

GUIDE TO THE METALLISATION CHARACTERISTIC

Zoe Max is a lamp made entirely by hand.

The process involved in manually producing a lamp of this size is very complex and requires hours of labour performed by skilled glassblowers. On a surface of such an extent, small imperfections may occur, especially during the finishing or metallisation process. Such imperfections attest to the fact that the product is handcrafted and further increase the value of the lamp.

The Cangini e Tucci company does not accept any complaints regarding micro-imperfections on the lamp surface.
(Please refer to the specific brochure of reference)

LEITFADEN FÜR METALLISIERUNGSMERKMALE

Zoe Max ist eine vollständig von Hand gefertigte Lampe. Die handwerkliche Herstellung einer Lampe dieser Größe ist sehr komplex und erfordert stundenlange Arbeit der Glasbläser. Auf einer Oberfläche dieser Größe können kleine Unregelmäßigkeiten auftreten, insbesondere in der Endbearbeitung oder während der Metallisierung. Diese Unvollkommenheiten beweisen, dass es sich um ein handgefertigtes Produkt handelt, und erhöhen den Wert der Lampe. Die Firma Cangini e Tucci akzeptiert keine Reklamationen bezüglich oberflächlicher Mikrofehler, die die Lampe aufweisen kann. (siehe Referenzbrochure)

SINGLE PENDANT with canopy



CODE	TRANSPARENT	COLOURED	COLOURED FUME (08)	BRONZE / BLACK	ROSE GOLD
MAX1303.1L	€ 1.482,00	€ 1.779,00	€ 1.954,00	€ 2.081,00	€ 2.269,00

* CODE without canopy for compositions



CODE	TRANSPARENT	COLOURED	COLOURED FUME (08)	BRONZE / BLACK	ROSE GOLD
MAX1303	€ 1.449,00	€ 1.746,00	€ 1.921,00	€ 2.048,00	€ 2.236,00

Description	Bulb (not included)	Cable	Net weight kg	Gross weight kg	Package cm
Single pendant, glass Ø45 H80 cm - LAC12 canopy	E27 1 x max 105W	150 cm	7,800	9,500	56 x 56 x 101

Description	Bulb (not included)	Cable	Net weight kg	Gross weight kg	Package cm
Single pendant without canopy, glass Ø45 H80 cm	E27 1 x max 105W	150 cm	7,800	9,500	56 x 56 x 101

METAL STRUCTURE AVAILABLE: matt black

GLASS COLOUR AVAILABLE: TRANSPARENT + serigraphs, METALLIC sky-blue, METALLIC sky-blue + serigraphs

ERHAETLICHE AUSFÜHRUNGEN DER METALLTEILE: Schwarz Matt

ERHAETLICHE GLASFARBEN: transparent + Siebdruck, Metallic-Blau, Metallic-Blau + Siebdruck

TABLE LAMP with lampshade

CODE	TRANSPARENT	METALLIC sky-blue	
LU1520	€ 806,00	€ 971,00	
LUGIG1520	€ 1.181,00	€ 1.433,00	
LUXXL1520	€ 1.746,00	€ 2.089,00	

WALL LAMP

CODE	METALLIC sky-blue	TRANSPARENT with serigraph	METALLIC sky-blue with serigraph
AP1521.1L	€ 663,00	€ 663,00	€ 724,00

SINGLE PENDANT with canopy

CODE	METALLIC sky-blue	TRANSPARENT with serigraph	METALLIC sky-blue with serigraph
1523.1L	€ 642,00	€ 642,00	€ 703,00
GIG1523.1L	€ 956,00	€ 956,00	€ 1.021,00
XXL1523.1L	€ 1.526,00	€ 1.526,00	€ 1.653,00

* CODE without canopy for compositions

CODE	METALLIC sky-blue	TRANSPARENT with serigraph	METALLIC sky-blue with serigraph
1523	€ 618,00	€ 618,00	€ 679,00
GIG1523	€ 932,00	€ 932,00	€ 997,00
XXL1523	€ 1.502,00	€ 1.502,00	€ 1.629,00

Composition example: TRACK STAINLESS POLISHED STEEL

CODE	METALLIC sky-blue	TRANSPARENT with serigraph	METALLIC sky-blue with serigraph
1527.120.3L	€ 2.107,00	€ 2.107,00	€ 2.290,00
GIG1527.120.3L	€ 3.049,00	€ 3.049,00	€ 3.244,00

Composition example: PLATE STAINLESS POLISHED STEEL

CODE	METALLIC sky-blue	TRANSPARENT with serigraph	METALLIC sky-blue with serigraph
1529MX.3L	€ 3.330,00	€ 3.330,00	€ 3.583,00



* TO CREATE **CUSTOM COMPOSITIONS**, USE THE PRICES **WITHOUT CANOPY** AND SELECT THE DESIRED STRUCTURE FROM PAGE 89 TO PAGE 105

- **BLACK RUBBER ELECTRIC CABLE**

SCHWARZES KABEL AUS GUMMI

- **ON DEMAND: WITH UL COMPONENTS +10% in addition**

AUF ANFRAGE: MIT UL KOMPONENTEN + 10% Aufpreis

LED AVAILABLE FOR TABLE LAMPS WITH SHADE / LED ERHÄLTlich FÜR TISCHLEUCHTE MIT LAMPENSCHIRM:

LED 4,3W 350 LUMEN 3.000K

LUMEN INDICATED CORRESPONDS TO THE LUMINOUS INTENSITY AT THE ORIGIN OF THE LED BOARD
DIE ANGEGBENEN LUMEN ENTSPRECHEN DER LICHTINTENSITÄT DER URSPRÜNGLICHEN LED-PLATINE

Description	Bulb (not included)	Cable	Net weight kg	Gross weight kg	Package cm
Table lamp Ø25 - H43 cm with lampshade	E14 1x max 40W LED 1x 4,3W included	200 cm	1,100	2,000	29 x 29 x 57 / 28 x 28 x 18
Table lamp Ø40 - H58 cm with lampshade	E27 1x max 60W LED 1x 4,3W included	200 cm	1,920	3,800	29 x 29 x 57 / 42 x 42 x 24
Table lamp Ø50 - H78 cm with lampshade	E27 1x max 60W LED 1x 4,3W included	200 cm	3,435	6,500	39 x 39 x 67 / 53 x 53 x 26

Description	Bulb (not included)	Cable	Net weight kg	Gross weight kg	Package cm
Wall lamp L16 P20 H58 cm	E14 1 x max 60W	50 cm	0,875	1,300	26 x 26 x 47

Description	Bulb (not included)	Cable	Net weight kg	Gross weight kg	Package cm
Single pendant, glass Ø16 H28 cm - EST10 canopy	E14 1 x max 60W	150 cm	0,790	1,300	26 x 26 x 47
Single pendant, glass Ø22 H38 cm - EST10 canopy	E27 1 x max 105W	150 cm	1,510	2,400	29 x 29 x 57
Single pendant, glass Ø30 H53 cm - EST10 canopy	E27 1 x max 105W	150 cm	2,500	4,300	39 x 39 x 67

Description	Bulb (not included)	Cable	Net weight kg	Gross weight kg	Package cm
Single pendant without canopy, glass Ø16 H28 cm	E14 1 x max 60W	150 cm	0,790	1,300	26 x 26 x 47
Single pendant without canopy, glass Ø22 H38 cm	E27 1 x max 105W	150 cm	1,510	2,400	29 x 29 x 57
Single pendant without canopy, glass Ø30 H53 cm	E27 1 x max 105W	150 cm	2,500	4,300	39 x 39 x 67

Description	Bulb (not included)	Cable	Net weight kg	Gross weight kg	Package cm
Track AUF120 L120 cm, 3x glass Ø16 H28 cm	E14 3 x max 60W	150 cm	2,900	5,600	10 x 10 x 162 / 41 x 41 x 42
Track AUF120 L120 cm, 3x glass Ø22 H38 cm	E27 3 x max 105W	150 cm	5,590	9,400	10 x 10 x 162 / 3X 29 x 29 x 57

Description	Bulb (not included)	Cable	Net weight kg	Gross weight kg	Package cm
Plate P43 Ø43 cm, glass Ø16-22-30 cm	E14 1 x max 60W E27 2 x max 105W	150 cm	6,480	14,700	51 x 51 x 14 / 39 x 39 x 67 29 x 29 x 57 / 26 x 26 x 47

GUIDE TO THE CHARACTERISTICS OF HAND-WORKED GLASS

BOROSILICATE GLASS COATING PROCESS

Borosilicate glass is readily available in a transparent form. However, unlike with soda glass, the physical and chemical properties of molten borosilicate glass prevent it from being directly coloured with oxides or pigments. To colour borosilicate glass, known commercially as Pyrex, another method must be adopted. The procedure for achieving this result uses vacuum deposition technology called Physical Vapour Deposition (PVD). With this system, the previously treated glass is introduced into a deposition chamber specifically designed to optimize its processing according to desired specifications. A vacuum is created in this chamber to facilitate deposition on the Pyrex substrate of the desired material, which can be a metal or an oxide, or a combination of both. The minimal thickness of the deposits is such that the coating in question is called a 'thin film', consisting of nano-technological coating deposits at the nanometre scale, which, even if they are

metallic, still allow the passage and diffusion of light. Therefore, glass that was previously limited to being transparent, can now assume a finish ranging from a metallic mirror to a transparent colouring effect. This process can be used to obtain various optical effects, since different deposition materials and different thicknesses of the same material will behave differently when light passes through them. In practice, the final effect is rather different from molten batch dye or paint coloured glass. The effect is instead an optical one determined by the type of material deposited and its thickness, meaning that the final product will react differently to different variations and wavelengths of light.

Direct disclosure is prohibited.
This document provided exclusively for information on the deposition process.

LEITFADEN ZU DEN MERKMALEN VON HANDGEFERTIGTEM GLAS

COATING VERFAHREN FÜR BOROSILIKATGLAS

Borosilikatglas ist in transparenter Form erhältlich. Wegen seiner chemophysikalischen Beschaffenheit ist diese Art von Glas nur in transparenter Form erhältlich und eine direkte Färbung vom geschmolzenen Glas mit Oxiden oder Pigmenten ist nicht möglich, wie man es normalerweise bei Natronglas macht. Um Borosilikatglas, im Handel auch bekannt unter dem Namen PIREX, zu färben, muss man ein anderes Verfahren anwenden. Um ein solches Resultat zu erreichen, ist eine Unter-Vakuum-Technologie, genannt PVD (Physical Vapour Deposition), das Verfahren, was man einsetzen muss. Bei diesem Verfahren wird das schon vorbehandelte Glas in entsprechende, eigens entwickelte Vakuumkammern gelegt, welche die Behandlung entsprechend den gewünschten Spezifikationen optimieren. In diesen Kammern wird ein Vakuum erzeugt. Das Vakuum ist notwendig, um auf dem Pyrex Substrat das gewünschte Material aufzutragen, welches ein Metall, ein Oxid oder eine Kombination beider sein kann.

Die Dicke der Beschichtung ist dergestalt, dass man es als THIN FILM bezeichnet. Tatsächlich handelt es sich hier um Dicken im nanometrischen Bereich. Auf das Glas werden also nanotechnologische

Schichten aufgetragen, was selbst bei Metallen auch noch die Diffusion von Licht zulässt, wenn dieses durch das Glas fällt. Das zuvor transparente Glas erhält nun eine Oberflächenbehandlung. Das kann reichen von einer metallischen Spiegelung bis hin zu einer transparenten Färbung. Das Charakteristische dieses Verfahrens ist es, spezielle optische Effekte zu erzielen, weil die unterschiedlichen Materialien ein unterschiedliches Lichtverhalten erzeugen; beim Lichteinfall, und bei unterschiedlichen Dicken desselben Materials resultiert dies unter und bei Lichteinfall in unterschiedlichem Materialverhalten. In der Praxis ist das Endresultat nicht dasselbe, wie bei einem mit Paste oder bei einem mittels Lack gefärbten Glas. Das Resultat ist vielmehr ein OPTISCHER Effekt, der abhängt von der Art des aufgetragenen Materials und von der Dicke dieses Materials. Aus diesem Grund wird man jeweils unterschiedliches Materialverhalten im Endprodukt haben, mit unterschiedlichem Verhalten gegenüber Licht und je nach Wellenlänge des Lichts.

Die direkte Verbreitung ist untersagt.
Das Dokument ist ausschließlich bestimmt als Information zum Beschichtungsverfahren.

SPECKS IN THE GLASS

Small dots on the glass are to be considered part of the craftsmanship process. Despite careful quality checks of the glass, small imperfections that are initially invisible to the naked eye may emerge during blowing.

KLEINE PUNKTE AUF DEM GLAS

Kleine Punkte auf der Oberfläche des Glases sind als Merkmale der Handwerkskunst zu berücksichtigen. Trotz sorgfältiger Qualitätskontrolle des Glases könnten beim Blasen kleine Unvollkommenheiten auftreten, die für das bloße Auge zunächst unsichtbar sind.

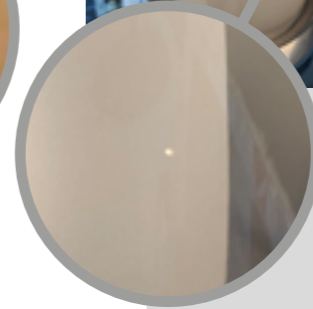
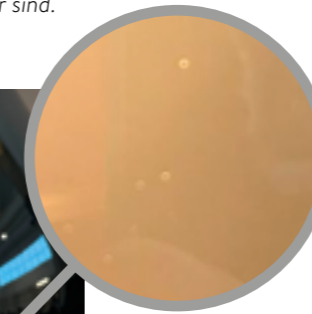

“IMPERFECTIONS” IN THE GLASS

The welding and workmanship of our glass is made entirely by hand. It could happen that bubbles appear at the junction points, or more or less obvious thicknesses, which we do not consider defects, but further attest to the authenticity of the craft work.

„UNVOLLKOMMENHEITEN“ DES GLASES

Das Schweißen und die Verarbeitung von unseren Gläsern werden komplett per Hand gefertigt. Es können kleine Bläschen in den Verbindungspunkten der Gläsern entstehen; das Glas kann auch unterschiedliche Dicken aufweisen. Diese „Unvollkommenheiten“ werten wir nicht als Mängel, sondern sie verleihen dem Produkt Authentizität, die durch die handwerkliche Fertigung entsteht.

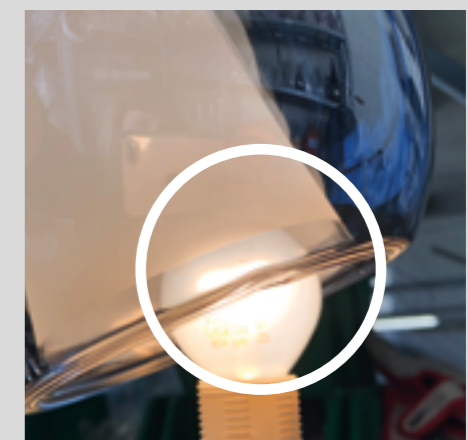
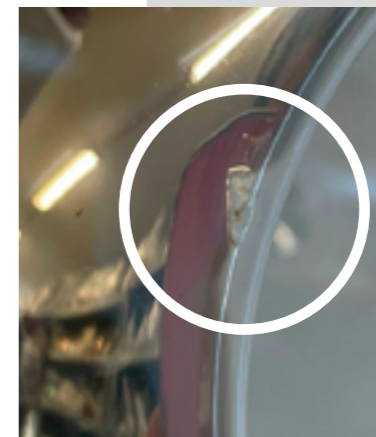

SURFACE COLOUR

The glass tonality of the metallization is the result of an elaborate handicraft process, it is not a RAL colour, the composition is made using a special chemical process in order to obtain the mirror-smooth effect, therefore slight differences in color or different shades are inevitable.

FARBE DER OBERFLÄCHE

Der Glasfarbton der Metallisierung ist das Ergebnis eines aufwendigen Handwerksprozesses. Es ist keine RAL Farbe und die Zusammensetzung erfolgt mit einem besonderen chemischen Verfahren um den spiegelglatten Effekt zu erhalten. Leichte Farbunterschiede oder unterschiedlicher Nuancen sind durch diese rein handwerkliche Verarbeitung unvermeidbar.



METALLIZATION

Small dots, marks and optical effects (invisible when the light is off), could emerge when switched on.

METALLISIERUNG

Kleine Punkte oder Imperfektionen können bei angeschaltetem Licht sichtbar sein, sind aber kaum wahrnehmbar, wenn das Licht ausgeschaltet ist.



DECOR

The decoration is made entirely by hand according to a design approved by the Van Gogh Museum and irregularities may appear in the execution.

DEKOR

Die Dekoration wird vollständig von Hand nach einem vom Van Gogh Museum genehmigten Design hergestellt, und bei der Durchführung können Unregelmäßigkeiten auftreten.

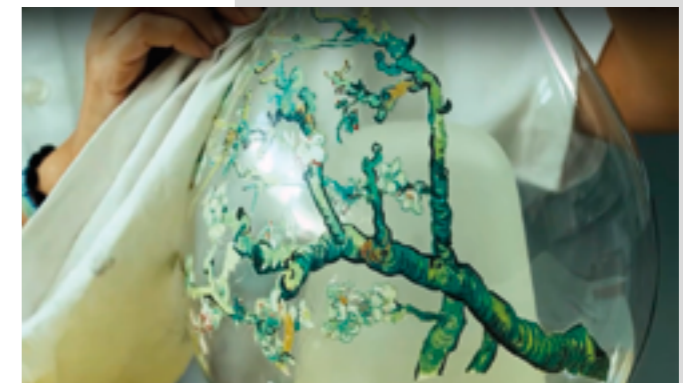
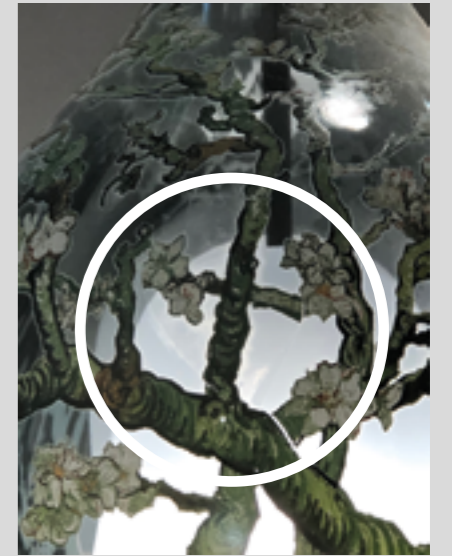

COLOUR SAMPLE KIT

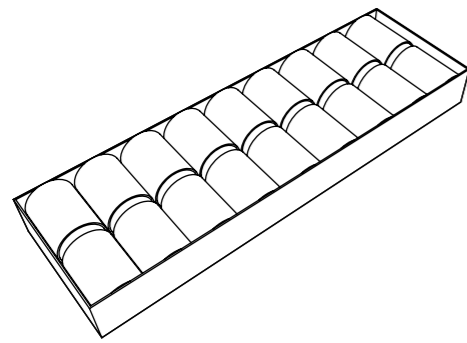

GLASS FINISHES

charge € 100,00

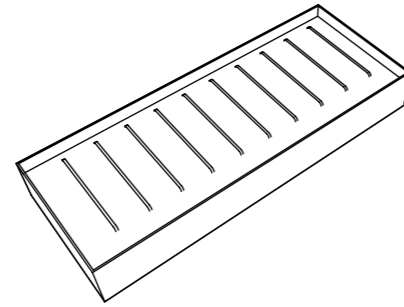

METAL FINISHES

charge € 50,00

STRUCTURES FOR COMPOSITIONS



SINGLE CANOPIES

90



MULTIPLE CANOPIES

92



SPACERS

94



CABLES AVAILABLE

95

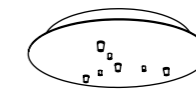

ROUND PLATES

96



SQUARE PLATES

98

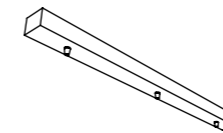

AUF TRACKS

100

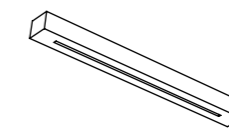

SLOT TRACKS

102



CUSTOM FIXTURES

104

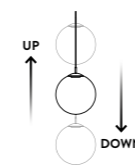

UP&DOWN SYSTEM

105

SINGLE CANOPIES

TO CREATE A CUSTOM COMPOSITION: TAKE THE PRICES OF THE PRODUCTS WITHOUT CANOPY AND ADD THE STRUCTURES HERE BELOW

STANDARD METAL STRUCTURE AVAILABLE: chrome, brushed chrome, matt white, matt black

FOR CUSTOMISED FINISHES PLEASE CONTACT OUR TECHNICAL DEPARTMENT AT: tecnico@canginetucci.com
 FÜR SONDERANFERTIGTE FARBENAUSFÜHRUNGEN KONTAKTIEREN SIE BITTE UNSERE TECHNISCHE BÜRO: tecnico@canginetucci.com

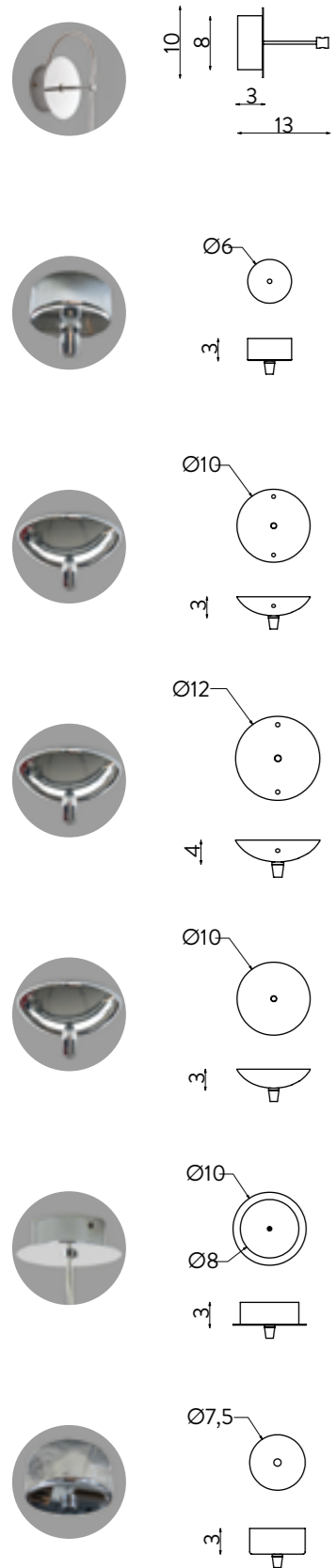

CODE	Description	CHROME, BRUSHED CHROME, MATT WHITE, MATT BLACK
API10	Wall lamp structure Ø10 - P3 cm (Zoe style)	€ 45,00
ECL6	Canopy Ø6 - H3 cm (Eclisse style)	€ 24,00
LAC10	Canopy Ø10 - H3 cm (Lacrime style)	€ 24,00
LAC12	Canopy Ø12 - H4 cm (Lacrime style)	€ 33,00
EST10	Canopy Ø10 - H3 cm without bracket holes (Lacrime style)	€ 24,00
GOC10/S	Canopy Ø10 - H3 cm	€ 27,00
AUF7,5	Canopy Ø7,5 - H3 cm (Auf style)	€ 24,00

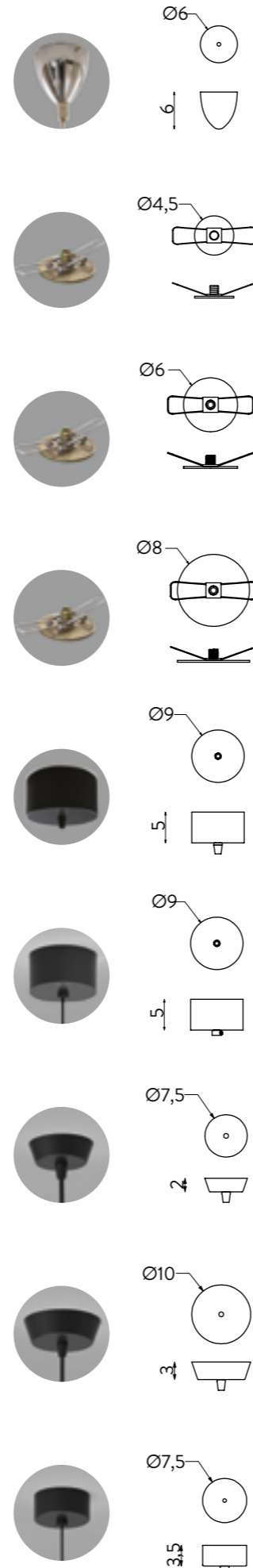

CODE	Description	CHROME, BRUSHED CHROME, MATT WHITE, MATT BLACK
FL6	Canopy Ø6 - H6 cm (Flute style)	€ 24,00
INC4,5	Canopy Ø4,5 cm recessed HOLE MAX: Ø3.5 cm	€ 33,00
INC6	Canopy Ø6 cm recessed HOLE MAX: Ø5 cm	€ 33,00
INC8	Canopy Ø8 cm recessed HOLE MAX: Ø7 cm	€ 33,00
FOL9	Canopy Ø9 - H5 cm (Fold style)	€ 24,00
PT9	Canopy Ø9 - H5 cm (Pit style) suitable for products with coaxial cable	€ 24,00
TRP7,5	Canopy Ø7,5 - H2 cm	€ 25,00
TRP10	Canopy Ø10 - H3 cm	€ 30,00
VE7,5	Canopy Ø7,5 - H3,5 cm (Vegetal style)	€ 24,00

CANOPIES for multiple suspensions

TO CREATE A CUSTOM COMPOSITION: TAKE THE PRICES OF THE PRODUCTS WITHOUT CANOPY AND ADD THE STRUCTURES HERE BELOW

STANDARD METAL STRUCTURE AVAILABLE: chrome, brushed chrome, matt white, matt black

FOR CUSTOMISED FINISHES PLEASE CONTACT OUR TECHNICAL DEPARTMENT AT: tecnico@canginetucci.com

FÜR SONDERANFERTIGTE FARBENAUSFÜHRUNGEN KONTAKTIEREN SIE BITTE UNSERE TECHNISCHE BÜRO: tecnico@canginetucci.com

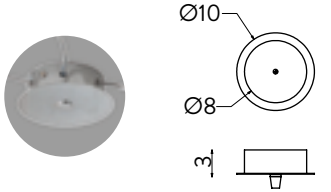
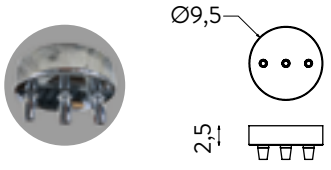
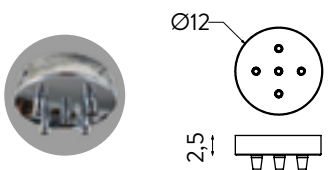
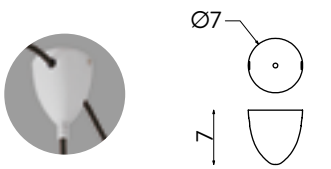
CODE	Description	CHROME, BRUSHED CHROME, MATT WHITE, MATT BLACK
 GOC10/M	Canopy Ø10 - H3 cm 2/6 side holes (+1 central) (not usable for low-voltage LED)	€ 27,00
 ECL9,5	Canopy Ø9,5 - H2,5 cm 3 holes on the bottom (1 is central) (not usable for low-voltage LED)	€ 27,00
 ECL12	Canopy Ø12 - H2,5 cm 5 holes on the bottom (1 is central) (not usable for low-voltage LED)	€ 29,00
 FL7	Canopy Ø7 - H7 cm 2 side holes (+1 central) (not usable for low-voltage LED)	€ 24,00

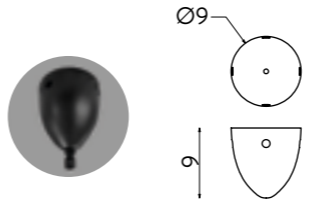
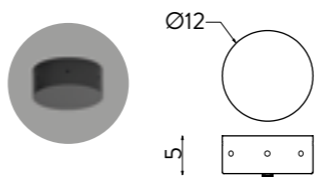
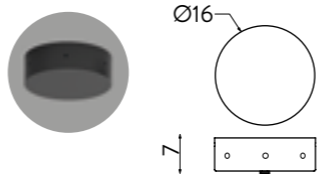



CODE	Description	CHROME, BRUSHED CHROME, MATT WHITE, MATT BLACK
 FL9	Canopy Ø9 - H9 cm 4 side holes (+1 central) (not usable for low-voltage LED)	€ 27,00
 PT12	Canopy Ø12 - H5 cm (side holes can be customized) on request: usable with low-voltage LED lamps	€ 50,00
 PT15	Canopy Ø16 - H7 cm (side holes can be customized) on request: usable with low-voltage LED lamps	€ 55,00

SPACERS for multiple suspensions

TO CREATE A CUSTOM COMPOSITION: TAKE THE PRICES OF THE PRODUCTS WITHOUT CANOPY AND ADD THE STRUCTURES HERE BELOW

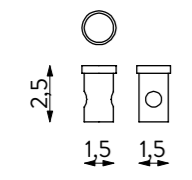
STANDARD METAL STRUCTURE AVAILABLE: chrome, brushed chrome, matt white, matt black

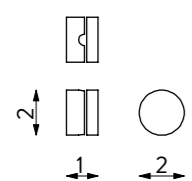
FOR CUSTOMISED FINISHES PLEASE CONTACT OUR TECHNICAL DEPARTMENT AT: tecnico@canginetucci.com
FÜR SONDERANFERTIGTE FARBENAUFSÜHRUNGEN KONTAKTIEREN SIE BITTE UNSERE TECHNISCHE BÜRO: tecnico@canginetucci.com

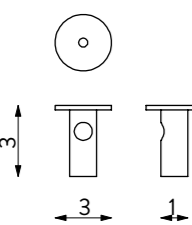
	CODE	Description	CHROME, BRUSHED CHROME, MATT WHITE, MATT BLACK
 	WS2	Cylindrical spacer Ø1,5 - H2,5 cm	€ 14,00
 	WS4	Spacer Ø2 - H 1 cm can be used as wall stud or spacer for the ceiling (recommended for lamps with coaxial cable)	€ 22,00
 	WS5	Cylindrical spacer with base support Ø3 - H3 cm (recommended for XXL lamps) <small>(on demand: the upper disc can be made with a different finish than the lower cylinder)</small>	€ 14,00

ELECTRIC CABLES to customize the length of the pendants

TO CUSTOMIZE THE LENGTH OF THE ELECTRIC CABLE, ADD THE PRICES HERE BELOW





Description	EXTRA CABLE PRICE PER METER
FEP TRANSPARENT TRIPOLAR SILICONE	€ 12,00
FEP TRANSPARENT BIPOLAR SILICONE	€ 12,00
BROWN BIPOLAR COLOURED SILICONE	€ 12,00
RED BIPOLAR COLOURED SILICONE	€ 12,00
TWISTED BIPOLAR TRANSPARENT SILICONE	€ 12,00
TRIPOLAR BLACK RUBBER	€ 12,00
TRIPOLAR BLACK TEXTILE	€ 12,00
BIPOLAR BLACK TEXTILE	€ 12,00
FEP BLACK BIPOLAR SILICONE	€ 12,00
TRANSPARENT COAXIAL CABLE	€ 18,00
BLACK COAXIAL CABLE	€ 18,00

ROUND PLATES

TO CREATE A CUSTOM COMPOSITION: TAKE THE PRICES OF THE PRODUCTS WITHOUT CANOPY AND ADD THE STRUCTURES HERE BELOW

STANDARD METAL STRUCTURE AVAILABLE: chrome, brushed chrome, matt white, matt black

FOR CUSTOMISED FINISHES PLEASE CONTACT OUR TECHNICAL DEPARTMENT AT: tecnico@canginietucci.com
FÜR SONDERANFERTIGTE FARBENAUFSÜHRUNGEN KONTAKTIEREN SIE BITTE UNSERE TECHNISCHE BÜRO: tecnico@canginietucci.com

CODE	Description	CHROME, BRUSHED CHROME, MATT WHITE, MATT BLACK
 P27	Plate Ø27 - H 3 cm	€ 218,00
 P43	Plate Ø43 - H 4 cm	€ 278,00
 P50	Plate Ø50 - H 4 cm	€ 381,00

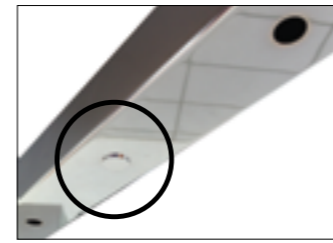

FOR **CUSTOMIZED PLATES** CONTACT OUR TECHNICAL OFFICE AT: tecnico@canginietucci.com

AS AN ALTERNATIVE TO SPECIAL PLATES, WE HAVE THE POSSIBILITY OF CLOSING THE HOLES OF THE EXISTING STRUCTURES WITH A PLUG OF THE SAME COLOR OF THE STRUCTURE (AS THE EXAMPLE).

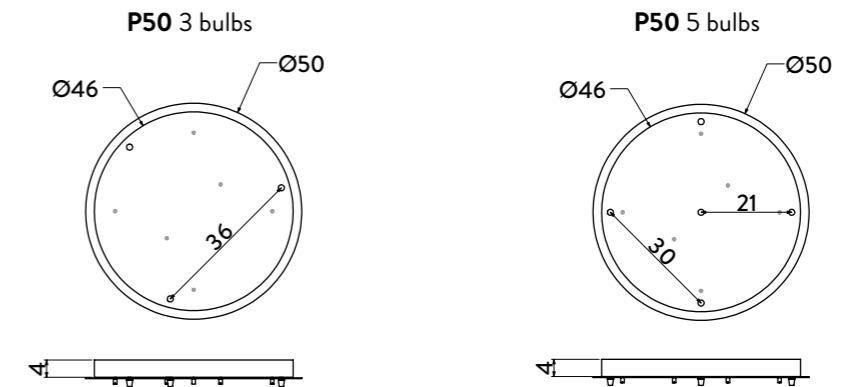
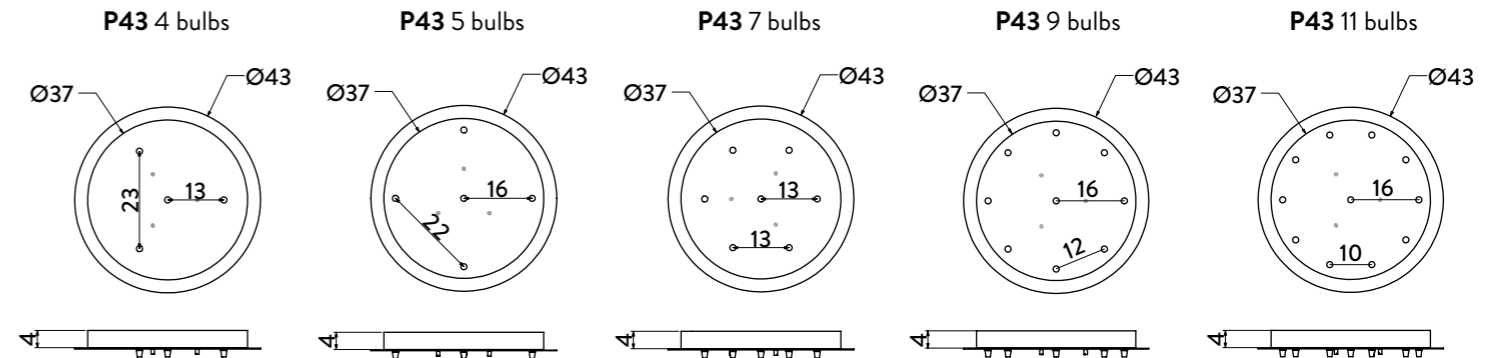
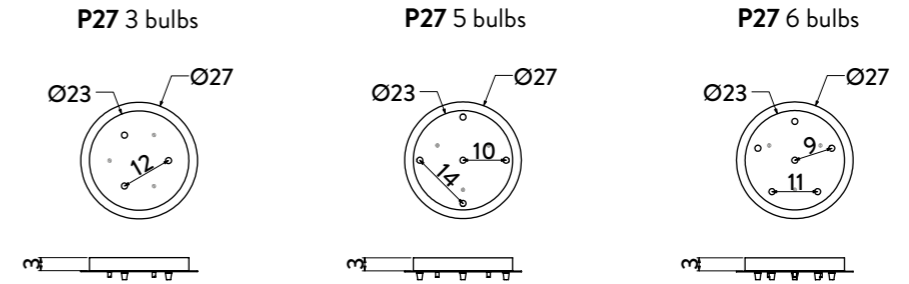

SQUARE AND RECTANGULAR PLATES

TO CREATE A CUSTOM COMPOSITION: TAKE THE PRICES OF THE PRODUCTS WITHOUT CANOPY AND ADD THE STRUCTURES HERE BELOW

STANDARD METAL STRUCTURE AVAILABLE: chrome, brushed chrome, matt white , matt black

FOR CUSTOMISED FINISHES PLEASE CONTACT OUR TECHNICAL DEPARTMENT AT: tecnico@canginietucci.com
FÜR SONDERANFERTIGTE FARBENAUSFÜHRUNGEN KONTAKTIEREN SIE BITTE UNSERE TECHNISCHE BÜRO: tecnico@canginietucci.com

	CODE	Description	CHROME, BRUSHED CHROME, MATT WHITE, MATT BLACK
	P30X30	Square plate 30x30 cm for 5 bulbs	€ 219,00
	P40X40	Square plate 40x40 cm for 5 bulbs	€ 266,00
	P35X100	Rectangular plate 35x100 cm for 5 bulbs NET Weight: 8,50 kg	€ 428,00
	P40X130	Rectangular plate 40x130 cm for 7 bulbs NET Weight: 12,00 kg	€ 574,00



FOR **CUSTOMIZED PLATES** CONTACT OUR TECHNICAL OFFICE AT: tecnico@canginietucci.com

AS AN ALTERNATIVE TO SPECIAL PLATES, WE HAVE THE POSSIBILITY OF CLOSING THE HOLES OF THE EXISTING STRUCTURES WITH A PLUG OF THE SAME COLOR OF THE STRUCTURE (AS THE EXAMPLE).

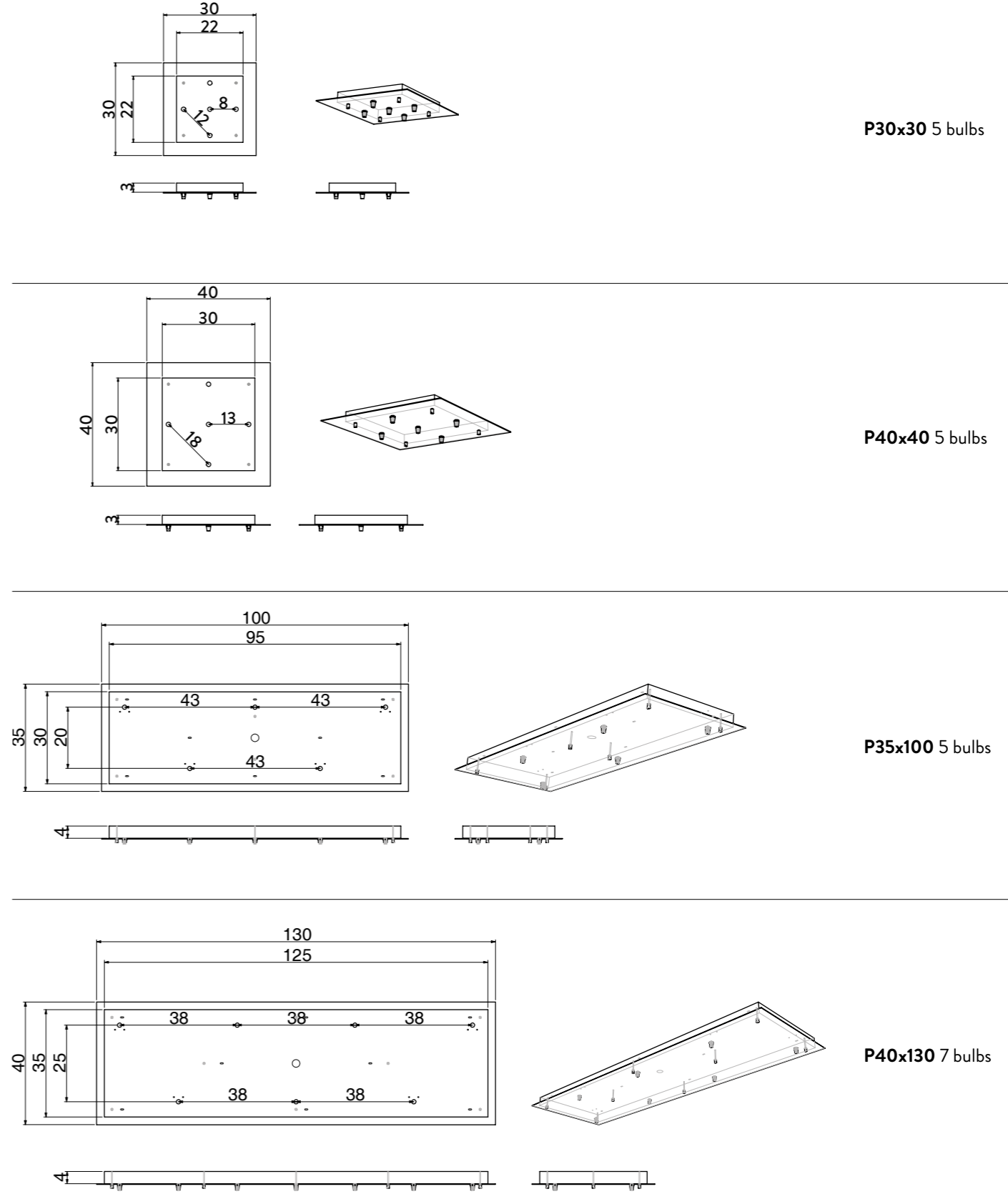

P30x30 5 bulbs

P40x40 5 bulbs

P35x100 5 bulbs



P40x130 7 bulbs

AUF TRACKS

TO CREATE A CUSTOM COMPOSITION: TAKE THE PRICES OF THE PRODUCTS WITHOUT CANOPY AND ADD THE STRUCTURES HERE BELOW

STANDARD METAL STRUCTURE AVAILABLE: chrome, brushed chrome, matt white , matt black

FOR CUSTOMISED FINISHES PLEASE CONTACT OUR TECHNICAL DEPARTMENT AT: tecnico@canginietucci.com
FÜR SONDERANFERTIGTE FARBENAUFSÜHRUNGEN KONTAKTIEREN SIE BITTE UNSERE TECHNISCHE BÜRO: tecnico@canginietucci.com

CODE	Description	CHROME, BRUSHED CHROME, MATT WHITE, MATT BLACK
 AUF90	Track 90x6xH5 cm for 3 bulbs	€ 217,00
 AUF120	Track 120x6xH5 cm for 3 bulbs	€ 253,00
 AUF150	Track 150x6xH5 cm for 3 or 5 bulbs	€ 296,00

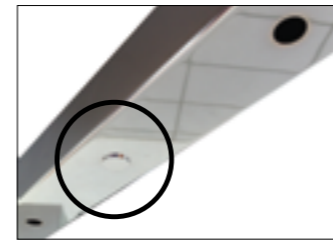

FOR **CUSTOMIZED TRACKS** CONTACT OUR TECHNICAL OFFICE AT: tecnico@canginietucci.com

AS AN ALTERNATIVE TO SPECIAL TRACKS, WE HAVE THE POSSIBILITY OF CLOSING THE HOLES OF THE EXISTING STRUCTURES WITH A PLUG OF THE SAME COLOR OF THE STRUCTURE (AS THE EXAMPLE).

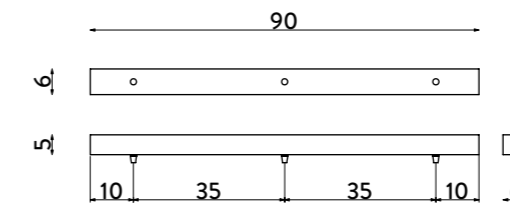

AUF90 3 bulbs

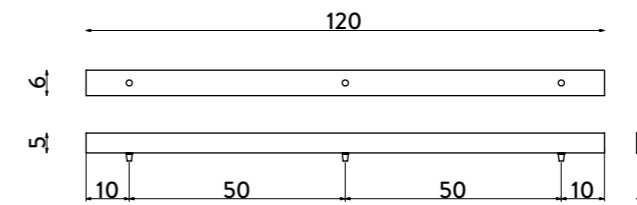

AUF120 3 bulbs

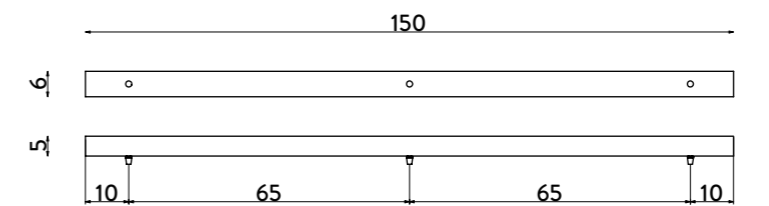

AUF150 3 bulbs

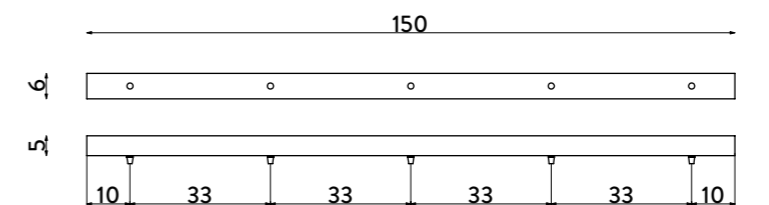





AUF150 5 bulbs

SLOT TRACKS

TO CREATE A CUSTOM COMPOSITION: TAKE THE PRICES OF THE PRODUCTS WITHOUT CANOPY AND ADD THE STRUCTURES HERE BELOW

STANDARD METAL STRUCTURE AVAILABLE: chrome, brushed chrome, matt white , matt black

FOR CUSTOMISED FINISHES PLEASE CONTACT OUR TECHNICAL DEPARTMENT AT: tecnico@canginietucci.com
FÜR SONDERANFERTIGTE FARBENAUSFÜHRUNGEN KONTAKTIEREN SIE BITTE UNSERE TECHNISCHE BÜRO: tecnico@canginietucci.com

	CODE	Description	CHROME, BRUSHED CHROME, MATT WHITE, MATT BLACK
	60T	Slot track 60x6xH5 cm	€ 252,00
	100T	Slot track 100x6xH5 cm	€ 266,00
	130T	Slot track 130x6xH5 cm	€ 281,00
	150T	Slot track 150x6xH5 cm	€ 307,00
	200T	Slot track 200x6xH5 cm	€ 404,00



FOR CUSTOMIZED TRACKS CONTACT OUR TECHNICAL OFFICE AT: tecnico@canginietucci.com

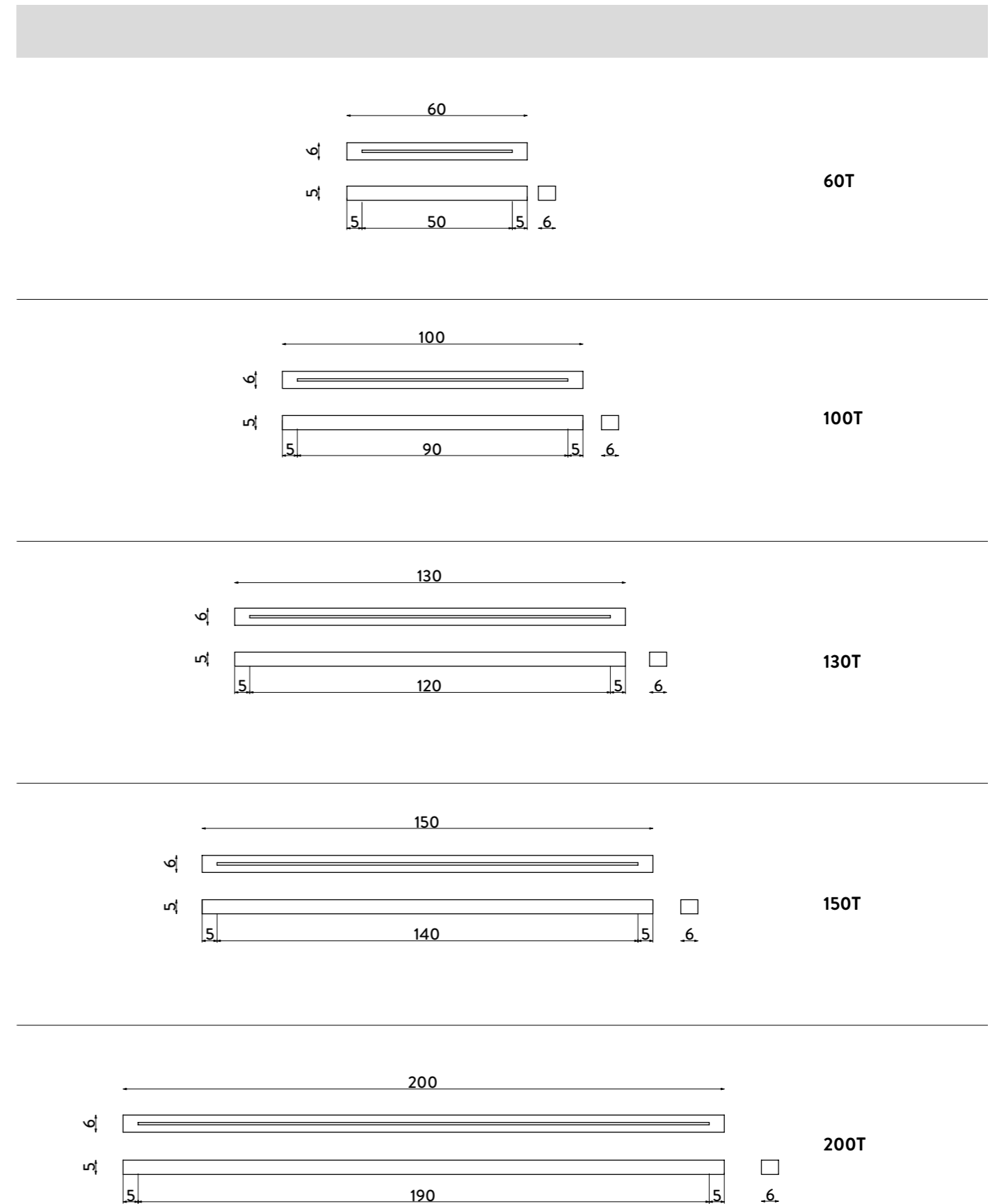

CUSTOM TRACKS (AUF AND SLOT)

TO CREATE A CUSTOM COMPOSITION: TAKE THE PRICES OF THE PRODUCTS WITHOUT CANOPY AND ADD THE STRUCTURES HERE BELOW

STANDARD METAL STRUCTURE AVAILABLE: chrome, brushed chrome, matt white, matt black

FOR CUSTOMISED FINISHES PLEASE CONTACT OUR TECHNICAL DEPARTMENT AT: tecnico@canginietucci.com
 FÜR SONDERANFERTIGTE FARBENAUSFÜHRUNGEN KONTAKTIEREN SIE BITTE UNSERE TECHNISCHE BÜRO: tecnico@canginietucci.com



CODE	Description	CHROME, BRUSHED CHROME, MATT WHITE, MATT BLACK
SPECIAL	Track from 50 to 100 cm	€ 360,00
SPECIAL	Track from 101 to 150 cm	€ 417,00
SPECIAL	Track from 151 to 200 cm	€ 463,00



WE REALIZE CUSTOMIZED PROJECTS

Please contact the technical office by email at the address export@canginietucci.com for a quote.

Upon request, we can supply customized plates and tracks of the diameter or length you need, and with a number of different outputs depending on the composition.

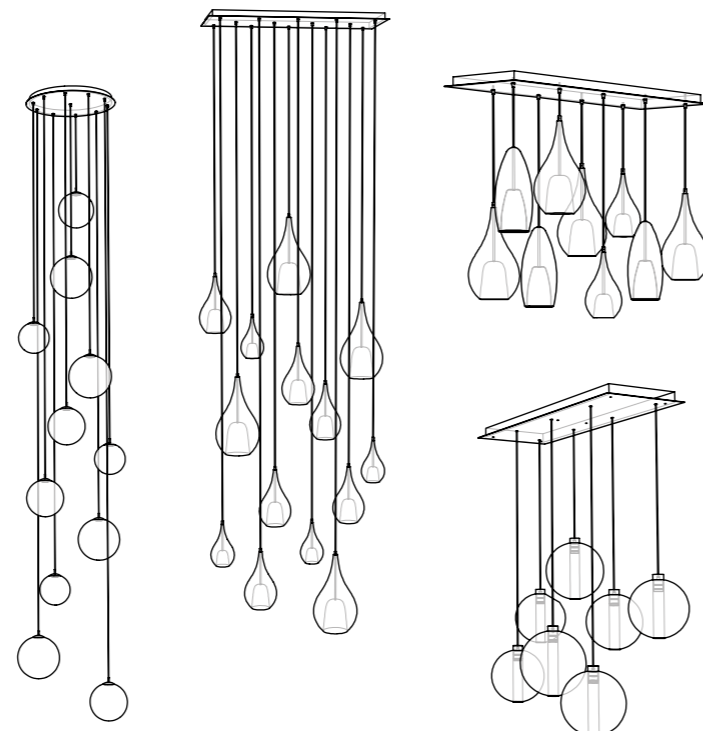

UP&DOWN SYSTEM FOR: DALMA, FIJI, FOLD, GEO, HYDRA, PIT

TO CREATE A CUSTOM COMPOSITION: TAKE THE PRICES OF THE PRODUCTS WITHOUT CANOPY AND ADD THE STRUCTURES HERE BELOW

STANDARD METAL STRUCTURE AVAILABLE: matt black

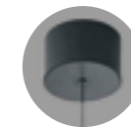
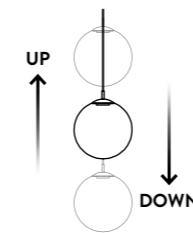

CODE	Description	PRICE
UD1	<p>UP&DOWN SYSTEM (maximum weight 1,8kg) CABLE AVAILABLE IN BLACK diam. 2,1mm COAXIAL CABLE 0,24M2 ADJUSTMENT: minimum length ca. 0,55m / maximum length 1,90m</p>	€ 358,00
UD2	<p>Aluminum CANOPY FOR UP&DOWN SYSTEM (mechanism excluded) matt black finish Dimensions: Ø11 H7 cm</p>	€ 119,00
UD3	<p>TRACK FOR UP&DOWN SYSTEM 3 pendants (mechanism excluded) Dimensions: L120 P9,5 H5 cm Hole position: 10-50-50-10</p>	€ 290,00

PIM / PRODUCT INFORMATION MANAGEMENT

DIGITAL PLATFORM TO SEE ALL COLLECTIONS AND DATA SHEETS



find out more



CEO

Pietro Tucci

ART DIRECTION

Cangini e Tucci
Alberto Manzoni

STAMPA

Litografia il Papiro

CANGINI&TUCCI S.r.l

Via Archimede, 36
47521 Cesena (FC)
Tel. +39 0547 303035
Fax +39 0547 645146
info@canginietucci.com
www.canginietucci.com

L'azienda si riserva il diritto di apportare modifiche
atte al miglioramento del prodotto
in qualsiasi momento e senza preavviso.

*The company reserves the right to make design
changes to improve the products
at any time and without notice.*