

ACE /
ACOUSTIC /
TRACK 48V /
TWENTY /
MAYA_MICRO /



ACE /
ACOUSTIC /
TRACK 48V /
TWENTY /
MAYA_MICRO /

news2024



ACE



IT_ ACE risponde alle tendenze del mercato all'ottimale ricerca di equilibrio tra efficienza, estetica e tecnologia. Forme semplici si uniscono a quanto di più evoluto offre l'elettronica per l'illuminazione contemporanea. ACE ha caratteristiche innovative, finiture curate ed attuali. Si installa a sospensione, a parete e soffitto ed è associabile ad altre componenti che ampliano il raggio d'impiego dell'apparecchio. Due le dimensioni, con schede Led di potenza diversa, proposte con finiture nero opaco, oro e bronzo. Disponibili soluzioni On/Off e dimmerabili.



EN_ACE responds to market trends in the optimal pursuit of balance between efficiency, aesthetics, and technology. Simple forms merge with the most advanced electronic offerings for contemporary lighting. ACE boasts innovative features, refined and current finishes. It can be installed as a suspension, wall, or ceiling fixture and can be combined with other components to expand its range of applications. It comes in two sizes, with Led boards of different power, available in matte black, gold, and bronze finishes. Both On/Off and dimmable solutions are available.

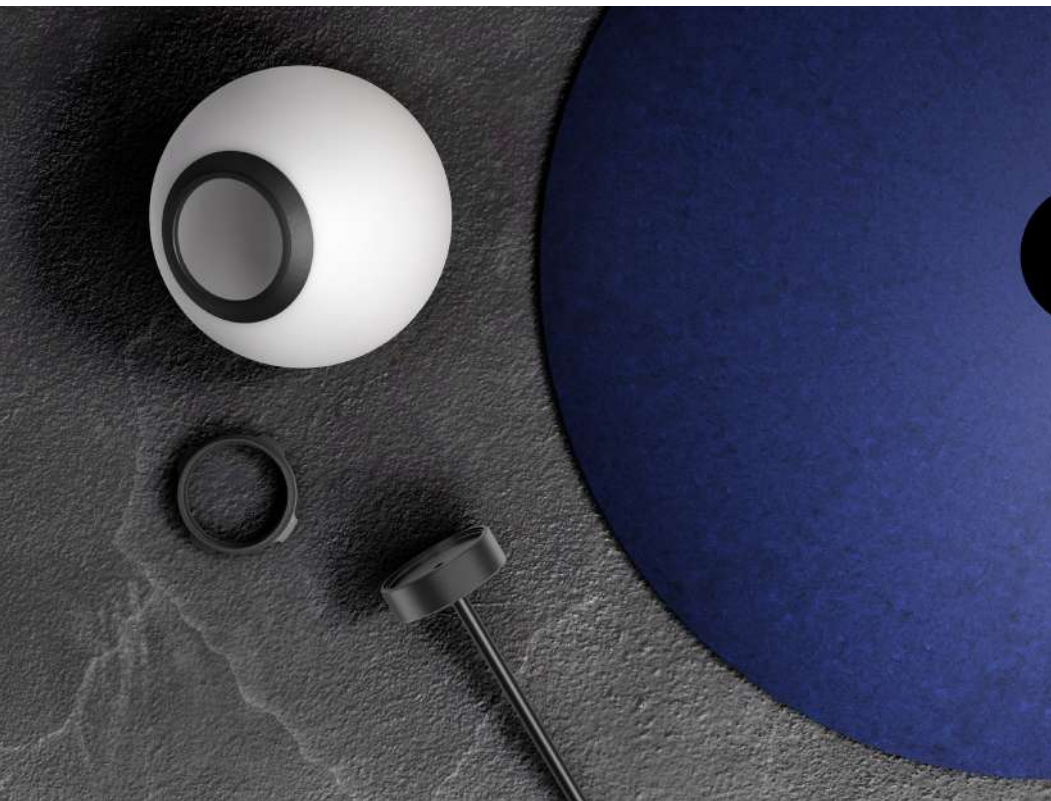
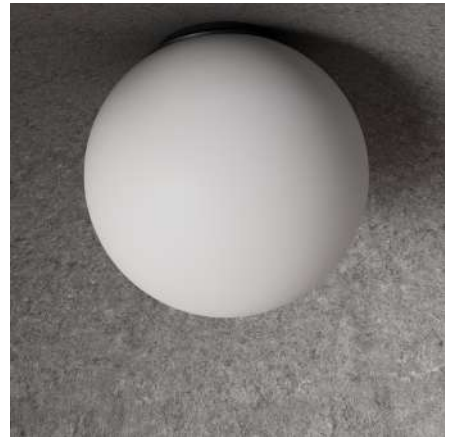

ACE



ACE_Led

IT_ACE Led è realizzato in alluminio con lavorazione CNC. Le finiture, con trattamento galvanico del metallo, sono nero opaco, oro e bronzo. Due le misure del gruppo Led con schede da 9W e 12W, disponibili nei toni colore 2700, 3000 e 4000K. Diffusore satinato antiabbagliamento. L'apparecchio si configura come sospensione oppure installazione da parete-soffitto. Diverse le opzioni per l'alimentazione; si sceglie tra versioni On/Off, DALI, Push.

EN_ACE Led is made of CNC aluminum work. The finishes, with galvanic treatment, are matt black, gold, bronze. Two sizes of the Led 9W and 12W boards, available in color tones 2700, 3000 and 4000K. Anti-glare satin diffuser. The luminaire can be suspended or wall-ceiling mounted. Several options for power: On/Off, DALI, Push.

ACE_Glass

IT_Una sfera in vetro satinato, diametro 15cm è l'elemento caratterizzante della versione ACE Glass. Si valorizza ulteriormente la qualità della scheda Led integrata (160lm/W). Oltre ad un marcato effetto estetico viene massimizzata la qualità e la morbidezza del flusso luminoso emesso. Questa soluzione è disponibile per installazione a sospensione oppure a parete - soffitto.

EN_A satin glass sphere, diameter 15cm is the basic element of the ACE Glass version. The quality of the integrated Led board (160lm/W) is further enhanced. In addition to a marked aesthetic effect is maximized the quality and softness of lumen flux. This solution is available for suspended or wall - ceiling installation.



PENDANT/
CEILING/
WALL/
9,5 W/
12 W/
2700K/
3000K/
4000K/
NERO/
ORO/
BRONZO/



ACE

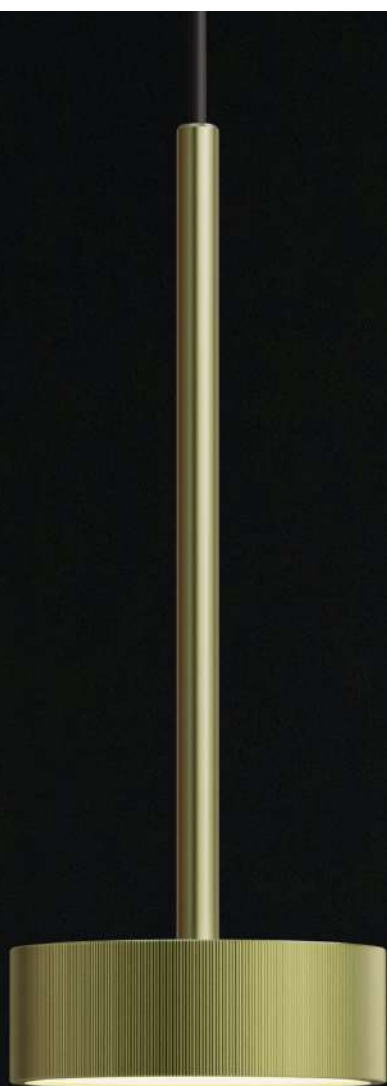

SOSPENSIONE



ACE_ Sospensione

LED



Power	Lumen output	Code to complete *
9,5 W	700 lm	BA-SB ■ ▲
◆ 350mA IP20		CRI>80 RG0 SCDM<3 - UP to 73 lm/W L80/B20 60.000 h. Lumen output values: luminaire luminous flux at 4000 K

12 W	1050 lm	BA-SC ■ ▲
◆ 400mA IP20		CRI>80 RG0 SCDM<3 - UP to 87 lm/W L80/B20 60.000 h. Lumen output values: luminaire luminous flux at 4000 K

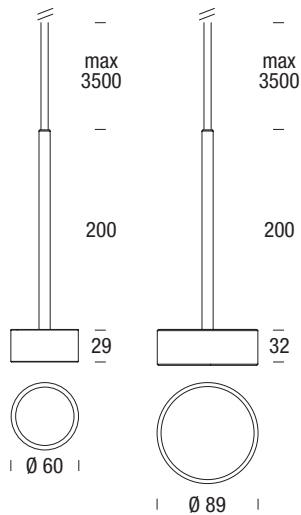

* Select your option

Colour		CCT	
Nero	B	2700 K	1
Oro	S	3000 K	2
Bronzo	Z	4000 K	3

ALIMENTAZIONE

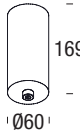
	Description	Code to complete *
	⚡ Rosone 220-240Vac, alimentatore incluso	LED, 9,5 W BSS02AB ● □ LED, 12 W BSS02AC ● □
	□ Incasso 220-240Vac, alimentatore incluso	LED, 9,5 W BSS04AB ● □ LED, 12 W BSS04AC ● □



* Select your option

Colour		Control	
Bianco	W	On/Off	NF
Nero	B	DALI	DA
		Push	PU

ACE_ Sospensione

GLASS



Power	Lumen output	Code to complete *
9,5 W	560 lm	AG-S ■ ▲

◆ 350mA | IP20

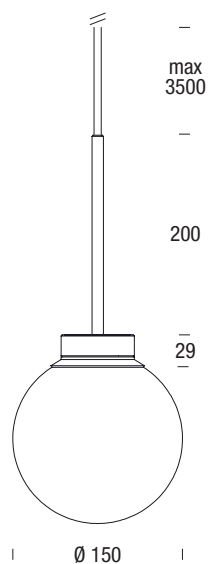

CRI>80 | RG0 | SCDM<3 - UP to 59 lm/W | L80/B20 60.000 h.
Lumen output values: luminaire luminous flux at 4000 K



* Select your option

Colour		CCT	
Nero	B	2700 K	1
		3000 K	2
		4000 K	3

ALIMENTAZIONE

	Description	Code to complete *
	Rosone LED, 9,5 W 220-240Vac, alimentatore incluso	BSS02AB ● □
	Incasso LED, 9,5 W 220-240Vac, alimentatore incluso	BSS04AB ● □

* Select your option

Colour		Control	
Bianco	W	On/Off	NF
Nero	B	DALI	DA
		Push	PU



ACE



SOFFITTO/PARETE

ACE_ Soffitto/Parete

LED

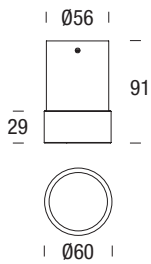

Power	Lumen output	Code to complete *
9,5 W	700 lm	BA-C ■ ▲

⊕ 220÷240Vac | IP20

CRI>80 | RG0 | SCDM<3 - UP to 73 lm/W | L80/B20 60.000 h.
Lumen output values: luminaire luminous flux at 4000 K

* Select your option

Colour		CCT	
Nero	B	2700 K	1
		3000 K	2
		4000 K	3

GLASS

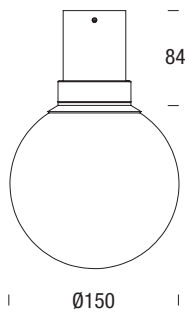

Power	Lumen output	Code to complete *
9,5 W	560 lm	AC-C ■ ▲

⊕ 220÷240Vac | IP20

CRI>80 | RG0 | SCDM<3 - UP to 59 lm/W | L80/B20 60.000 h.
Lumen output values: luminaire luminous flux at 4000 K

* Select your option

Colour		CCT	
Nero	B	2700 K	1
		3000 K	2
		4000 K	3

ACE

ACOUSTIC

En_ The ACOUSTIC version integrates an element with sound-absorbing characteristics to the ACE light unit. The diffuser, made of high density polyethylene, is suitable to make the interior acoustics of a room more welcoming and improve the acoustic comfort. The thermoformed material is totally recyclable, environmentally friendly, does not use chemicals, adhesives and dyes. Ace ACOUSTIC comes in 3 sizes: 45, 60 and 90cm. Four colors in the range: gray, red, green and blue



IT_ La versione ACOUSTIC integra un elemento con caratteristiche fonoassorbenti al gruppo luce ACE. La calotta, realizzata in polietilene ad alta densità, è adatta a rendere più accogliente l'acustica interna di un ambiente e migliorarne il comfort acustico. Il materiale termoformato è totalmente riciclabile, ecologico, non utilizza sostanze chimiche, collanti e coloranti. Ace ACOUSTIC viene proposta in 3 dimensioni: 45, 60 e 90cm. Quattro i colori nella gamma: grigio, rosso, verde e blu.

**“LOW
NOISE,
BETTER
LIVING”**

**LA QUALITÀ
ACUSTICA
DELL’AMBIENTE
MIGLIORA
LE TUE
GIORNATE**



ACE_Acoustic



ACE_Acoustic / Led

IT_La versione Acoustic Led è la sintesi perfetta di estetica e funzionalità. Si configura come sospensione oppure installazione da parete-soffitto e viene proposta con diffusore in 3 misure: 45, 60 e 90cm. Due le potenze del gruppo luminoso installato: 9W e 12.5W. Apprezzabile l'efficienza e la versatilità della scheda Led (160lm/W) disponibile nelle tonalità colore 2700-3000-4000K.

En_The Acoustic Led version is the perfect synthesis of aesthetics and functionality. It can be configured as a suspension or wall-ceiling installation, available in 3 sizes: 45, 60 and 90cm. Two powers of the light engine: 9W and 12.5W. Remarkable efficiency and versatility of the Led board (160lm/W) available in color tone 2700-3000-4000K.

ACE_Acoustic / Glass

IT_La versione Acoustic Glass aggiunge un elemento estetico alla versione Led. La sfera in vetro satinato, diametro 15 cm, è un valore aggiunto nella diffusione luminosa dell'apparecchio. L'emissione, pur mantenendo elevata intensità, acquista valori aggiuntivi per qualità e morbidezza.

En_The Acoustic Glass version adds an aesthetic element to the Led version. The satin glass sphere, diameter 15 cm, is an added value in the light diffusion of the luminaire. The emission, while maintaining high intensity, acquires additional values for quality and softness.



ACE_Acoustic / E27

IT_La proposta E27 è il naturale completamento del progetto ACE Acoustic. La semplicità di un portalampade garantisce al committente la totale libertà nella scelta della sorgente luminosa. Ampio spazio quindi a lampadine Led con colori, forme e misure caratterizzate e caratterizzanti. Ogni installazione viene valorizzata dal componente più particolare ed adatto all'ambiente.

En_E27 proposal is the natural completion of the ACE Acoustic project. The simplicity of a lamp holder guarantees the customer total freedom in choosing the light source. Large space for Led bulbs with colors, shapes and sizes characterized and characterizing. Each installation is enhanced by the most particular component and suitable for the environment.





45 Ø/
60 Ø/
90 Ø/
GRIGIO/
BLU/
ROSSO/
VERDE/

ACE_Acoustic_ Sospensione

LED



Power	Lumen output	Code to complete *
9,5 W	700 lm	AA-SB ■ ▲
◆ 350mA IP20		CRI>80 RG0 SCDM<3 - UP to 73 lm/W L80/B20 60.000 h. Lumen output values: luminaire luminous flux at 4000 K

12 W	1050 lm	AA-SC ■ ▲
◆ 400mA IP20		CRI>80 RG0 SCDM<3 - UP to 87 lm/W L80/B20 60.000 h. Lumen output values: luminaire luminous flux at 4000 K

* Select your option

Colour		CCT	
Nero	B	2700 K	1
		3000 K	2
		4000 K	3

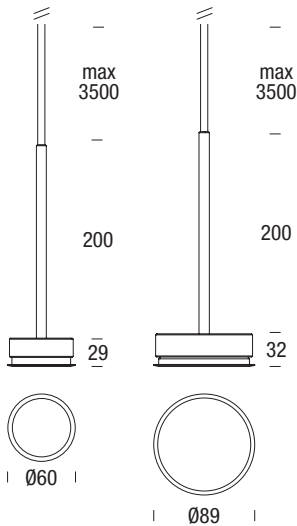

ALIMENTAZIONE

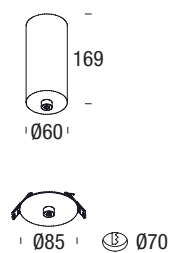

Description		Code to complete *
⊕ Rosone 220-240Vac, alimentatore incluso	LED, 9,5 W	BSS02AB ● □
	LED, 12 W	BSS02AC ● □
□ Incasso 220-240Vac, alimentatore incluso	LED, 9,5 W	BSS04AB ● □
	LED, 12 W	BSS04AC ● □

* Select your option

Colour		Control	
Bianco	W	On/Off	NF
Nero	B	DALI	DA
		Push	PU

CALOTTA

Description		Code to complete *
Calotta	Ø 450_H.80 (only: 9,5 W)	BSS01A ●●
	Ø 600_H.154 (only: 9,5 W)	BSS01B ●●
	Ø 900_H.248 (only: 12 W)	BSS01C ●●



* Select your option

Colour	
Grigio / Grey	G
Blu / Blue	B
Rosso / Red	R
Verde / Green	Y

ACE_Acoustic_Sospensione

GLASS



Power	Lumen output	Code to complete *
9,5 W	560 lm	AC-S ■ ▲
◆ 350mA IP20		CRI>80 RG0 SCDM<3 - UP to 59 lm/W L80/B20 60.000 h. Lumen output values: luminaire luminous flux at 4000 K

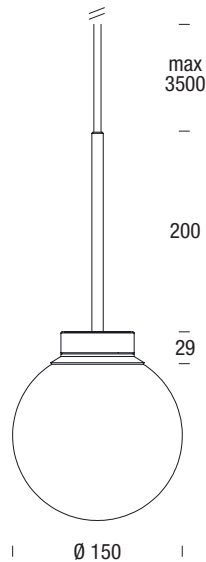

* Select your option

Colour		CCT	
Nero	B	2700 K	1
		3000 K	2
		4000 K	3

ALIMENTAZIONE

	Description	Code to complete *
⊕	Rosone LED, 9,5 W 220-240Vac, alimentatore incluso	BSS02AB ● □
□	Incasso LED, 9,5 W 220-240Vac, alimentatore incluso	BSS04AB ● □

* Select your option

Colour		Control	
Bianco	W	On/Off	NF
Nero	B	DALI	DA
		Push	PU

CALOTTA

Description		Code to complete *
Calotta	Ø 450_H.80	BSS01A ❖ ❖
	Ø 600_H.154	BSS01B ❖ ❖



* Select your option

Colour	
Grigio / Grey	G
Blu / Blue	B
Rosso / Red	R
Verde / Green	Y

ACE_Acoustic_ Sospensione

E27





Socket	Power	Code
E27	1x Max 40 W	AB-S

220~240Vac I IP20

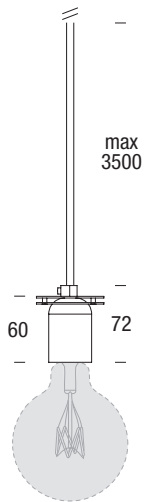
Lamp not included





ALIMENTAZIONE

	Description	Code
 30 Ø100	<input type="checkbox"/> Rosone 220-240Vac	Nero BSS02BB
 Ø85  Ø70	<input type="checkbox"/> Incasso 220-240Vac	Bianco BSS04BW Nero BSS04BB

CALOTTA



Description	Code to complete *
Calotta Ø 450_H.80	BSS01A 
Ø 600_H.154	BSS01B 

* Select your option

Colour	
Grigio / Grey	G
Blu / Blue	B
Rosso / Red	R
Verde / Green	Y

ACE_Acoustic_ Soffitto/Parete

LED



Power	Lumen output	Code to complete *
9,5 W On/Off	700 lm	AA-C ■ △

◇ 350mA | IP20

CRI>80 | RG0 | SCDM<3 - UP to 73 lm/W | L80/B20 60.000 h.
Lumen output values: luminaire luminous flux at 4000 K

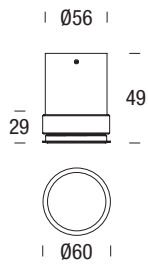

* Select your option

Colour		CCT	
Nero	B	2700 K	1
		3000 K	2
		4000 K	3

CALOTTA



Description	Code to complete *
Calotta Ø 450_H.80	BSS01A ❖❖
Ø 600_H.154	BSS01B ❖❖

* Select your option

Colour	
Grigio / Grey	G
Blu / Blue	B
Rosso / Red	R
Verde / Green	Y

ACE_Acoustic_ Soffitto/Parete

GLASS



Power	Lumen output	Code to complete *
9,5 W On/Off	560 lm	AC-C ■ ▲

◇ 350mA | IP20

CRI>80 | RG0 | SCDM<3 - UP to 59 lm/W | L80/B20 60.000 h.
Lumen output values: luminaire luminous flux at 4000 K

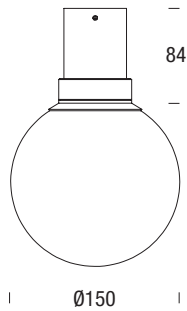

* Select your option

Colour		CCT	
Nero	B	2700 K	1
		3000 K	2
		4000 K	3

CALOTTA

Description	Code to complete *
Calotta Ø 450_H.80	BSS01A ❖❖
Ø 600_H.154	BSS01B ❖❖



* Select your option

Colour	
Grigio / Grey	G
Blu / Blue	B
Rosso / Red	R
Verde / Green	Y



TRACK 48V

COLLECTION

SUPERFICIE_ Slim
SOSPENSIONE_ Slim

1000 mm
2000 mm
3000 mm

Bianco / Nero

SUPERFICIE_ Deep
SOSPENSIONE_ Deep

1000 mm
2000 mm
3000 mm

Bianco / Nero



SOSPENSIONE_Up/Down

1000 mm
2000 mm
3000 mm

Bianco / Nero

INCASSO_Trimless

1000 mm
2000 mm
3000 mm

Nero

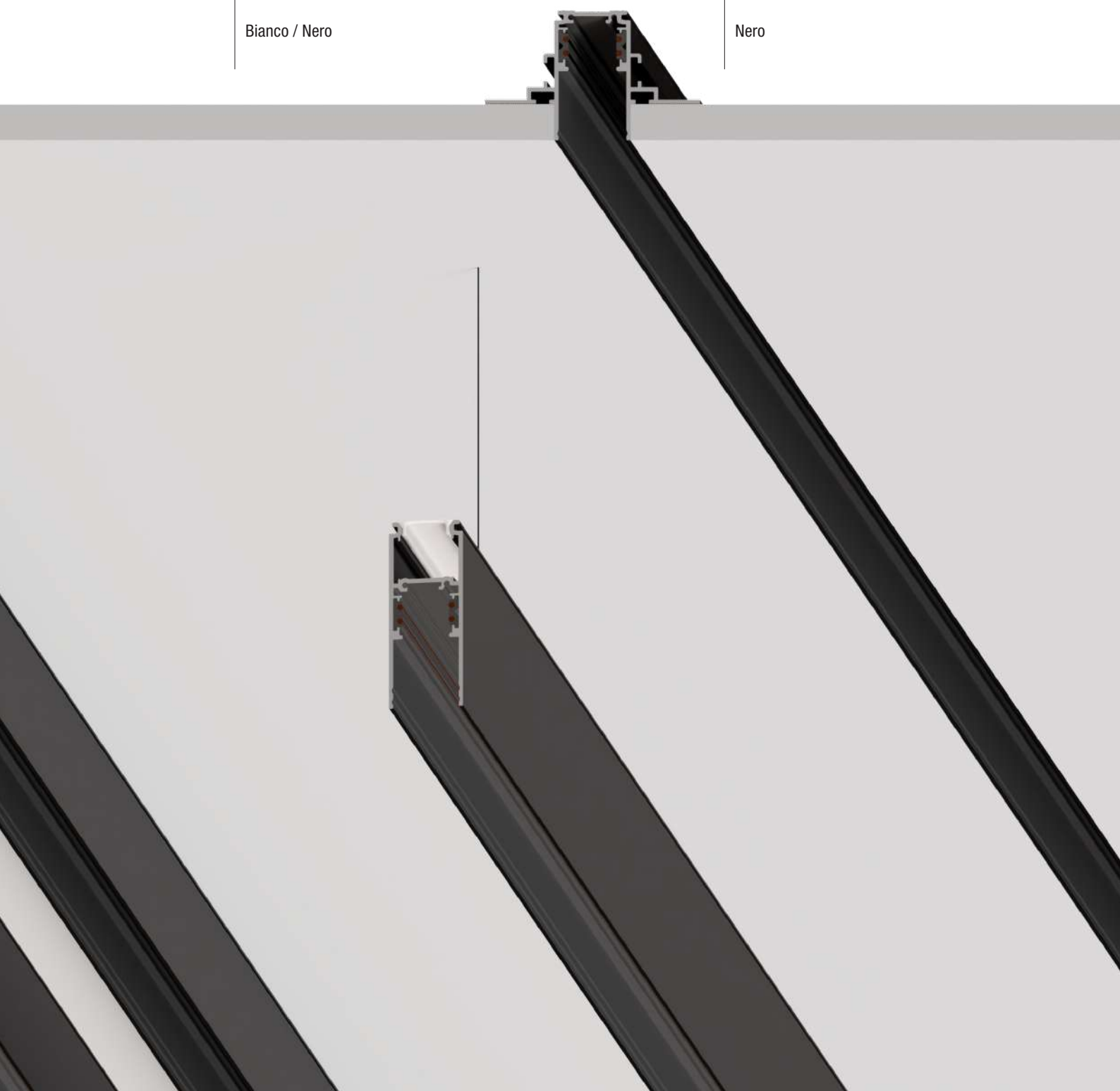

TRACK 48V

COLLECTION

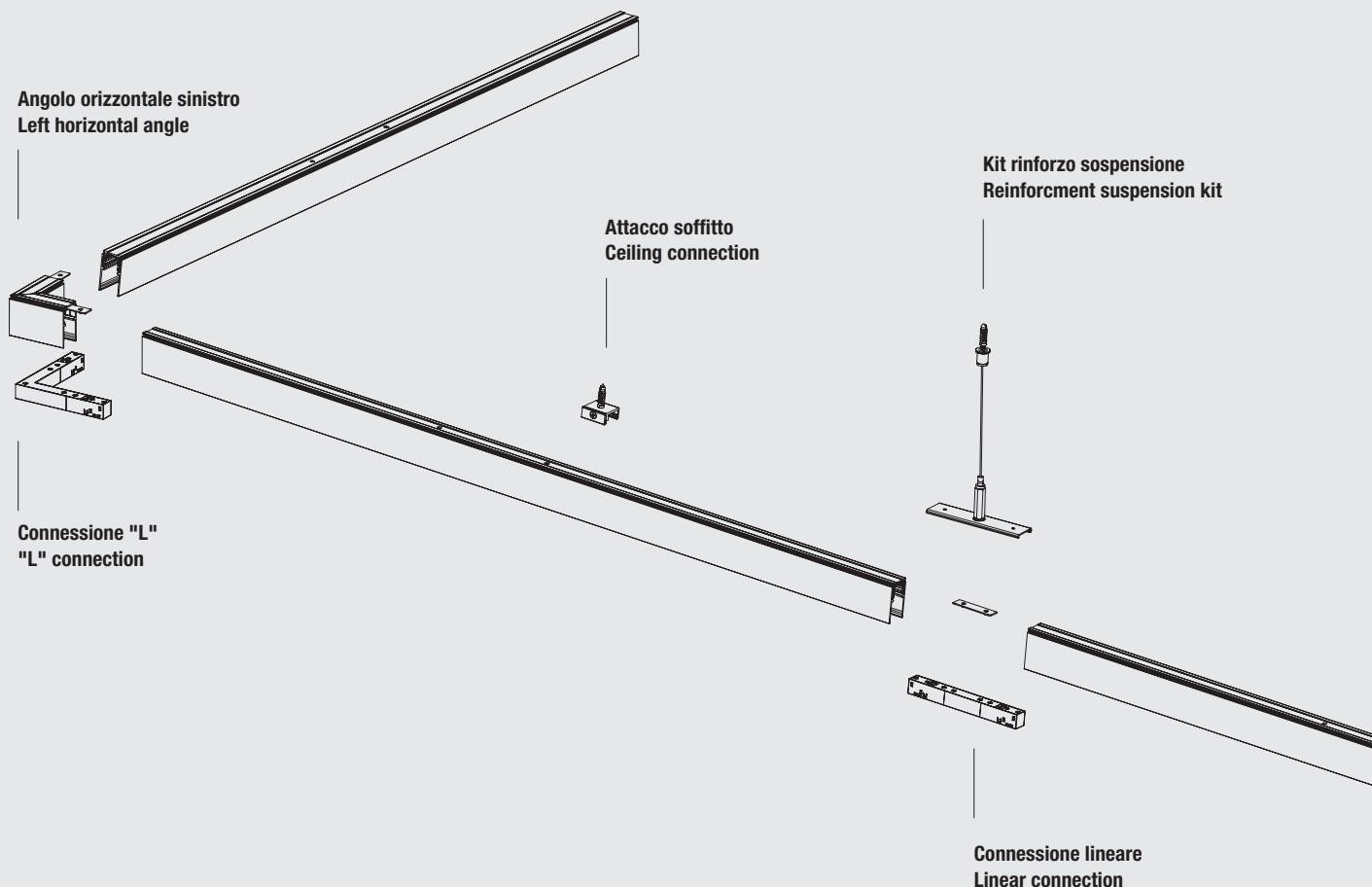

IT_ La linea TRACK 48V offre un programma completo di binari in bassissima tensione per uso interno. Ogni binario, in estrusione di alluminio, è disponibile in bianco e nero. Sono 4 i conduttori elettrificati in rame; due linee sono dedicate all'alimentazione, 2 linee si utilizzano per i dati. Diverse le tipologie d'installazione: Soffitto-Parete, Sospensione ed Incasso.

I singoli binari elettrificati si differenziano poi per estetica: Slim con dimensione ridotta, Deep, Up/Down e Incasso con sezione appofondita che nasconde completamente il driver del prodotto alla vista. Ogni tipologia d'installazione ha una serie di accessori che consentono lo sviluppo di linee, angoli e forme secondo necessità. Il sistema si completa con la sezione alimentatori: Si può scegliere tra l'alimentazione diretta sul binario con driver dedicato (On/Off o DALI) oppure con driver remoto.

EN_ The TRACK 48V line offers a complete program of low-voltage tracks for indoor use. Each track, made of extruded aluminum, is available in white and black. There are 4 electrified copper conductors; two lines are dedicated to power supply, and 2 lines are used for data. Various installation types are available: Ceiling-Wall, Suspension, and Recessed

The individual electrified tracks then differ in aesthetics: Slim with reduced dimensions, Deep, Up/Down, and Recessed with a deep section that completely hides the product's driver from view. Each installation type has a range of accessories that allow the development of lines, corners, and shapes as needed. The system is completed with the power supply section: You can choose between direct power supply to the track with a dedicated driver (On/Off or DALI) or with a remote driver.

Attacco sospensione
Suspension connection



Angolo verticale interno
Internal vertical angle



Angolo orizzontale sinistro
Left horizontal angle

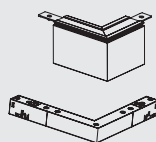

Connessione flessibile
Flex connection



Connessione "L"
"L" connection

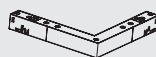

Testata aliment. sinistra
Left live end



Terminale
End cap

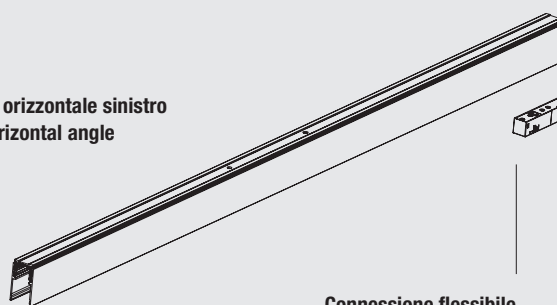
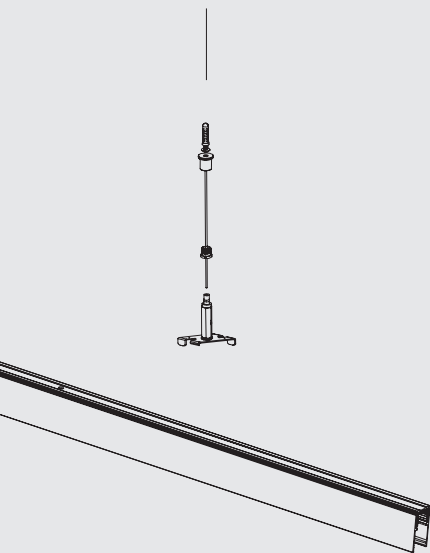

TRACK 48V

Superficie / Sospensione_ Small

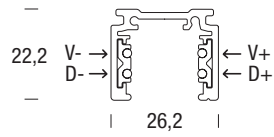

Model	Colour	Code
1000 mm	Bianco	48-AAAW
	Nero	48-AAAB
2000 mm	Bianco	48-AABW
	Nero	48-AABB
3000 mm	Bianco	48-AACW
	Nero	48-AACB

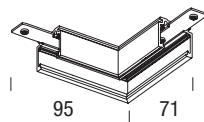

Angolo orizzontale sinistro Left horizontal angle	Bianco	48-ABAW
	Nero	48-ABAB

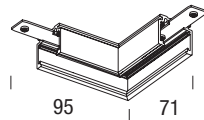

Angolo orizzontale destro Right horizontal angle	Bianco	48-ABBW
	Nero	48-ABBB

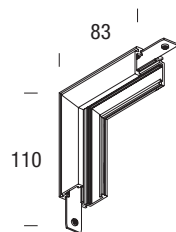

Angolo verticale interno Internal vertical angle	Bianco	48-ABCW
	Nero	48-ABCB

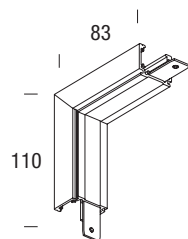

Angolo verticale esterno External vertical angle	Bianco	48-ABDW
	Nero	48-ABDB



Terminale End cap	Bianco	48-ABEW
	Nero	48-ABEB

TRACK 48V

Superficie / Sospensione_Deep

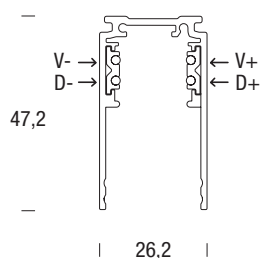

Model	Colour	Code
1000 mm	Bianco	48-DAAW
	Nero	48-DAAB
2000 mm	Bianco	48-DABW
	Nero	48-DABB
3000 mm	Bianco	48-DACW
	Nero	48-DACB

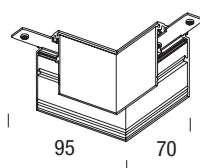

Angolo orizzontale sinistro Left horizontal angle	Bianco	48-DBAW
	Nero	48-DBAB

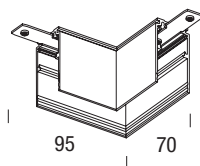

Angolo orizzontale destro Right horizontal angle	Bianco	48-DBBW
	Nero	48-DBBB

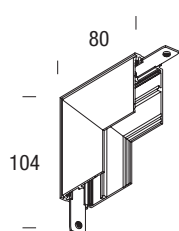

Angolo verticale interno Internal vertical angle	Bianco	48-DBFW
	Nero	48-DBFB

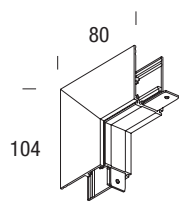

Angolo verticale esterno External vertical angle	Bianco	48-DBGW
	Nero	48-DBGB



Terminale End cap	Bianco	48-DBEW
	Nero	48-DBEB

TRACK 48V

Sospensione_ Up/Down

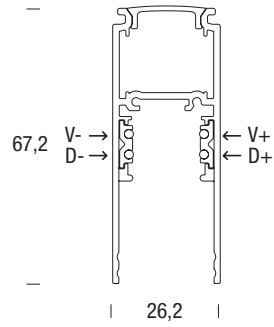

Model	Colour	Code
1000 mm	Bianco	48-CAAW
	Nero	48-CAAB
2000 mm	Bianco	48-CABW
	Nero	48-CABB
3000 mm	Bianco	48-CACW
	Nero	48-CACB

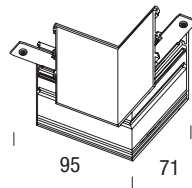

Angolo orizzontale sinistro Left horizontal angle	Bianco	48-CBAW
	Nero	48-CBAB

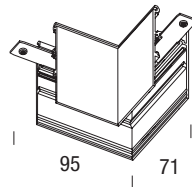

Angolo orizzontale destro Right horizontal angle	Bianco	48-CBBW
	Nero	48-CBBB



Terminale End cap	Bianco	48-CBEW
	Nero	48-CBEB

TRACK 48V

Incasso_Trimless

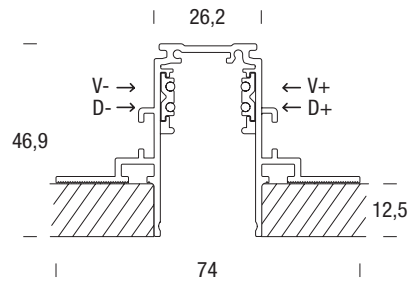
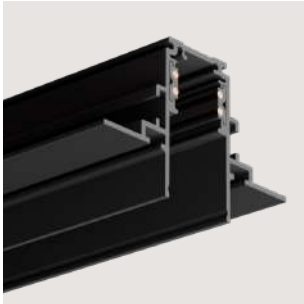

 50 mm

Model	Colour	Code
1000 mm	Nero	48-BAAB
2000 mm	Nero	48-BABB
3000 mm	Nero	48-BACB

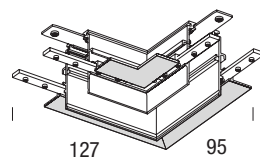

Angolo orizzontale sinistro Left horizontal angle	Nero	48-BBAB
---	------	---------

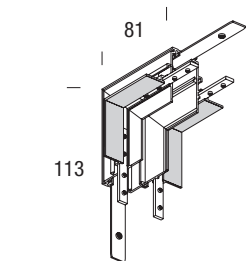

Angolo orizzontale destro Right horizontal angle	Nero	48-BBBB
--	------	---------

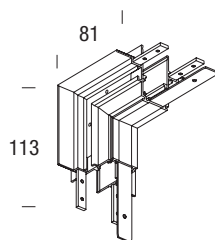

Angolo verticale interno Internal vertical angle	Nero	48-BBFB
--	------	---------

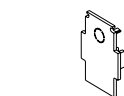

Angolo verticale esterno External vertical angle	Nero	48-BBGB
--	------	---------

Terminale End cap	Nero	48-BBEB
-----------------------------	------	---------

TRACK 48V_ Componenti elettrici

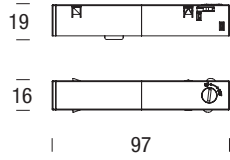

Testata alimentazione sinistra Left live end	Bianco	48-ABHW
	Nero	48-ABHB

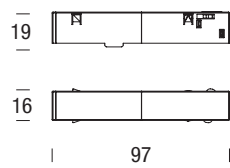

Testata alimentazione destra Right live end	Bianco	48-ABIW
	Nero	48-ABIB

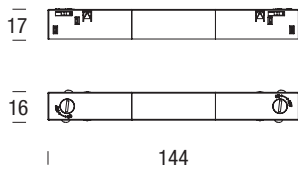

Connessione lineare Linear connection	Bianco	48-ABMW
	Nero	48-ABMB

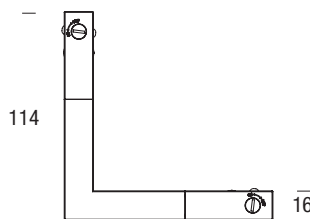

Connessione "L" "L" connection	Bianco	48-ABNW
	Nero	48-ABNB

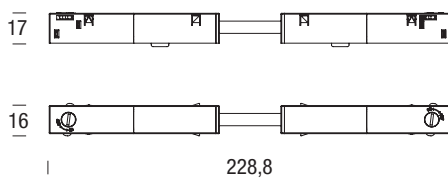

Connessione flessibile Flex connection	Bianco	48-ABOW
	Nero	48-ABOB

TRACK 48V_Accessori



| 30 | | 27,7 |

Attacco soffitto	Bianco	48-ABPW
Ceiling connection	Nero	48-ABPB

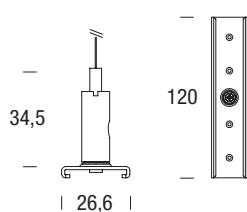

| 26,6 |

Kit rinforzo sospensione	Bianco	48-ABSW
cavo 3 metri		
Reinforcement suspension kit	Nero	48-ABSB
3 meters cable		

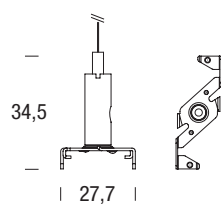

| 27,7 |

Attacco sospensione	Bianco	48-ABTW
cavo 3 metri		
Suspension connection	Nero	48-ABTB
3 meters cable		

TRACK 48V_ DRIVER SU BINARIO

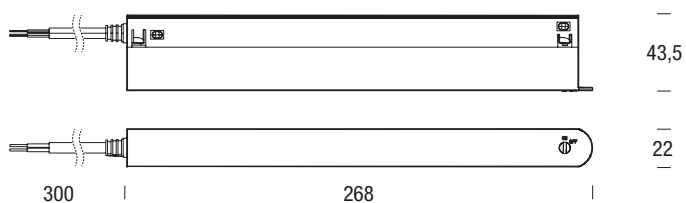
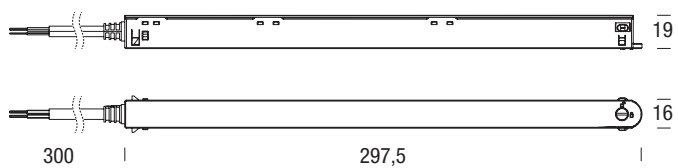

Driver elettronico 48Vdc 220-240Vac - 50/60 Hz 100W; DALI ; Class II; IP20	Bianco	48-ABQW
	Nero	48-ABQB

Driver elettronico 48Vdc 220-240Vac - 50/60 Hz 250W; DALI ; Class II; IP20	Bianco	48-ABRW
	Nero	48-ABRB

TRACK 48V_ DRIVER REMOTO

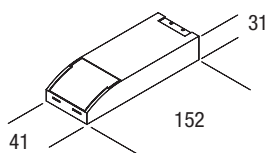

Driver elettronico 48Vdc 220-240Vac - 50/60 Hz 60W; On /Off ; Class II; IP20	DRV4801
---	----------------

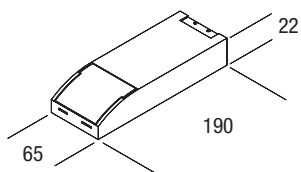

Driver elettronico 48Vdc 220-240Vac - 50/60 Hz 120W; On /Off ; Class II; IP20	DRV4802
--	----------------

ESEMPIO DI CONFIGURAZIONE

Vista dall'alto

CONFIGURATION EXAMPLE

Top view

ELECTRICAL COMPONENTS

 **1** Testata alimentazione Sx
Left live end
48-ABHW
48-ABHB

 **2** Testata alimentazione Dx
Right live end
48-ABIW
48-ABIB

 **3** Connessione lineare
Linear connection
48-ABMW
48-ABMB

 **4** Connessione L
L connection
48-ABNW
48-ABNB

MECHANICAL JOINTS

 **A** Angolo orizzontale sinistro
Left horizontal angle

 **B** Angolo orizzontale destro
Right horizontal angle

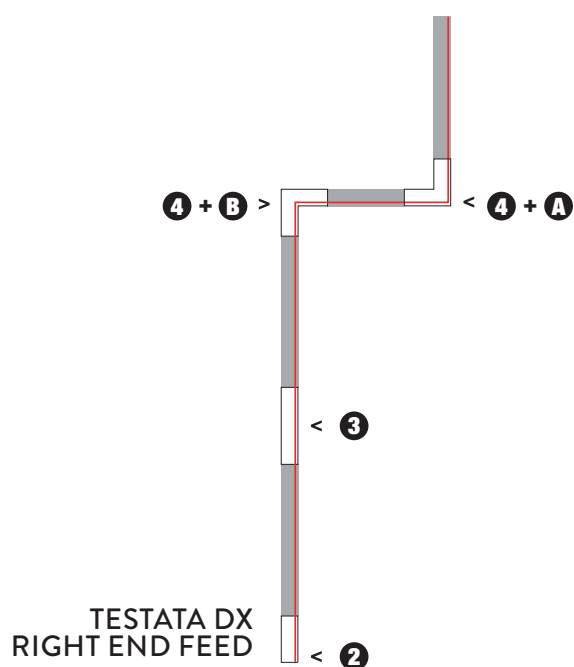
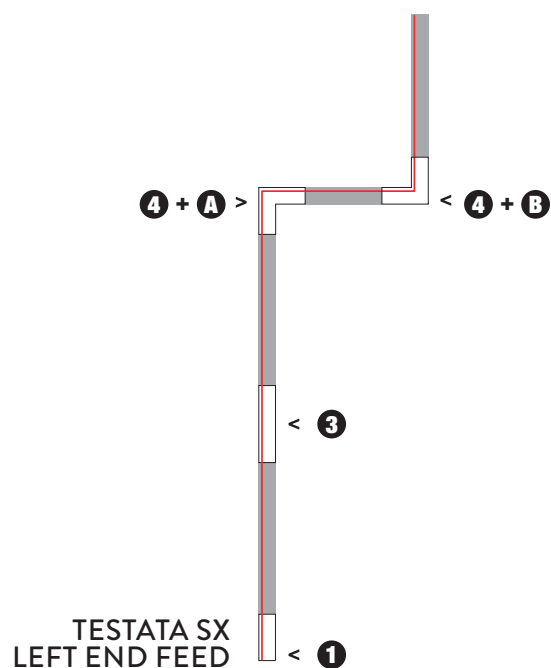

TRACK LIGHTING

COLLECTION







EVOQUE

5_10_15 W

2700_3000_4000 K

24°_38°_55°

On/Off_Dali

Bianco_Nero_Bronzo_
Titanio_Acciaio spazzolato_
Oro spazzolato

EVOQUE ZOOM

10_15 W

2700_3000_4000 K

15°-36°

On/Off_Dali

Bianco_Nero

MAYA_MICRO

300_600_900 mm

5_10_15 W

2700_3000_4000 K

30°_55°_120°_Microprismatico

On/Off_Dali

Bianco_Nero

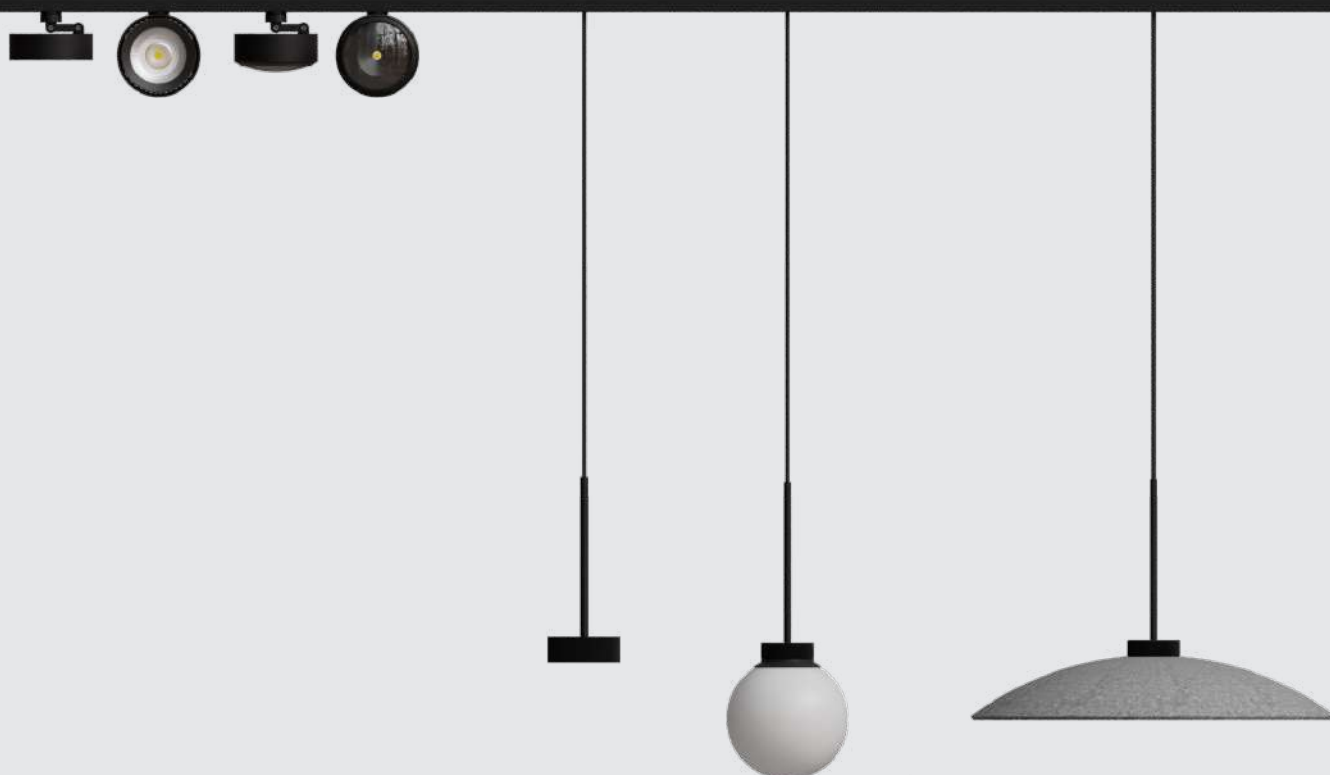

EXTREME

12_18 W

2700_3000_4000 K

15°_24°_38°_55°_120°

On/Off_Dali

Bianco_Nero_Oro Rosa_
Bronzo spazzolato_Titanio_
Acciaio spazzolato_
Oro spazzolato

ACE_LED

9,5 W

2700_3000_4000 K

120°

On/Off_Dali

Nero_Oro_Bronzo

ACE_SPHERE

9,5 W

2700_3000_4000 K

120°

On/Off_Dali

Nero

ACE_ACOUSTIC

9,5 W

2700_3000_4000 K

120°

On/Off_Dali

Nero

Calotta:
Grigio_Blu_Rosso_Verde

EVOQUE

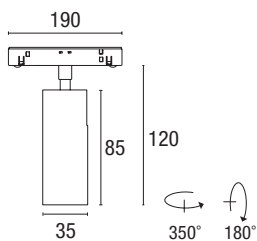

Power **Lumen output** **Source** **Weight** **Code to complete ***

5 W 487 lm CoB LED 0,15 kg **TT-AA** ● ■ ▲ ∴ □

◆ 48Vdc | IP20

CRI>90 | RG1 | SCDM<3 - UP to 97,4 lm/W | L80/B20 80.000 h.
Lumen output values: luminaire luminous flux at 4000 K - optics 24°

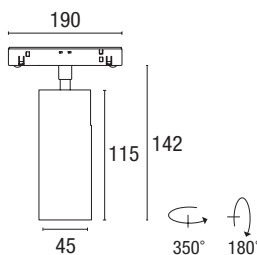

10 W 874 lm CoB LED 0,23 kg **TT-AB** ● ■ ▲ ∴ □

◆ 48Vdc | IP20

CRI>90 | RG1 | SCDM<3 - UP to 97,4 lm/W | L80/B20 80.000 h.
Lumen output values: luminaire luminous flux at 4000 K - optics 24°

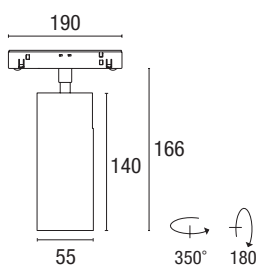

15 W 1238 lm CoB LED 0,40 kg **TT-AC** ● ■ ▲ ∴ □

◆ 48Vdc | IP20

CRI>90 | RG1 | SCDM<3 - UP to 97,4 lm/W | L80/B20 80.000 h.
Lumen output values: luminaire luminous flux at 4000 K - optics 24°

*** Select your option**

Colour adapter	●	CCT	■	Optic	▲	Control	∴	Colour	□
Bianco	W	2700 K	1	24°	2	On/Off	NV	Bianco	W
Nero	B	3000 K	2	38°	3	DALI	DV	Nero	B
		4000 K	3	55°	4			Bronzo	Z
								Titanio	T
								Acciaio spazzolato	A
								Oro spazzolato	Y



EVOQUE_ZOOM

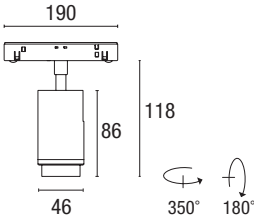

Power	Lumen output	Source	Optical	Weight	Code to complete *
10 W	614 lm	CoB LED	Zoom 15°-36°	0,30 kg	TZ-AB ● ■ ☺ □
◇ 48Vdc IP20		CRI>90 RG1 SCDM<3 - UP to 61 lm/W L80/B20 80.000 h. Lumen output values: luminaire luminous flux at 4000 K			

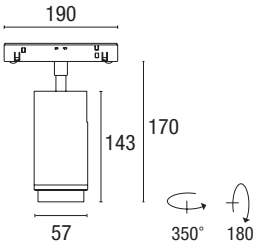

Power	Lumen output	Source	Optical	Weight	Code to complete *
15 W	1069 lm	CoB LED	Zoom 15°-36°	0,36 kg	TZ-AC ● ■ ☺ □
◇ 48Vdc IP20		CRI>90 RG1 SCDM<3 - UP to 61 lm/W L80/B20 80.000 h. Lumen output values: luminaire luminous flux at 4000 K			

*** Select your option**

Colour adapter		CCT		Control		Colour	
Bianco	W	2700 K	1	On/Off	NV	Bianco	W
Nero	B	3000 K	2	DALI	DV	Nero	B
		4000 K	3				

EXTREME_Track

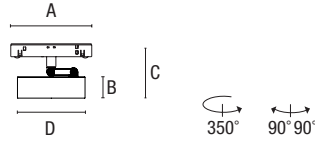

Power	Lumen output	Product dimension				Weight	code to complete*
		A	B	C	D		
12W	1447 lm	190 mm	32 mm	77 mm	103 mm	0,43 kg	TF-AA
18W	1852 lm	190 mm	32 mm	77 mm	103 mm	0,43 kg	TF-AB

48Vdc | IP20

CoB LED | CRI>90 | RG1 | SDCM<3

UP to 104 lm/W | L80/B20 80.000 h.

Lumen output values: luminaire luminous flux at 4000 K - optics 38°

* Select your option

Colour Adapter	CCT	Optic	Control	Colour Ring
Bianco W	2700 K 1	15° 1	On/Off NV	Bianco W
Nero B	3000 K 2	24° 2	DALI DV	Nero B
	4000 K 3	38° 3		Oro rosa S
		55° 4		Bronzo spazzolato Z
				Titanio T
				Acciaio spazzolato A
				Oro spazzolato Y

EXTREME_Track

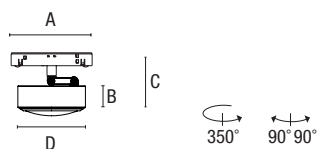
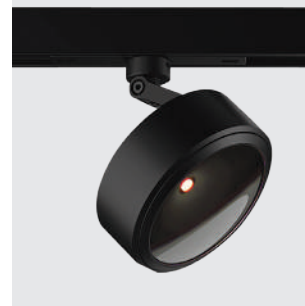

Power	Lumen output	Product dimension				Weight	code to complete *
		A	B	C	D		
12W	1128 lm	190 mm	47 mm	92 mm	103 mm	0,55 kg	TF-AA
18W	1852 lm	190 mm	47 mm	92 mm	103 mm	0,55 kg	TF-AB

48Vdc | IP20

CoB LED | CRI>90 | RG1 | SDCM<3
 UP to 88 lm/W | L70/B10 60.000 h.
 Lumen output values: luminaire luminous flux at 4000 K

* Select your option

Colour Adapter	CCT	Optic	Control	Colour Ring
Bianco W	2700 K 1	120° 5	On/Off NV	Bianco W
Nero B	3000 K 2		DALI DV	Nero B
	4000 K 3			Oro rosa S
				Bronzo spazzolato Z
				Titanio T
				Acciaio spazzolato A
				Oro spazzolato Y

ACE_Led

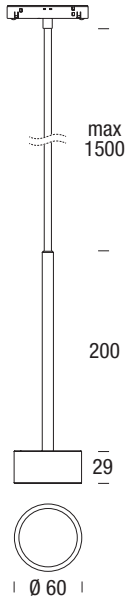

Power	Lumen output	Code to complete *
9,5 W	700 lm	CA-SB ■ ▲ ❖

◆ 48Vdc | IP20

CRI>80 | RG0 | SCDM<3 - UP to 73 lm/W | L80/B20 60.000 h.
Lumen output values: luminaire luminous flux at 4000 K

*** Select your option**

Colour		CCT		Control	
Nero	B	2700 K	1	On/Off	NV
Oro	S	3000 K	2	DALI	DV
Bronzo	Z	4000 K	3		

ACE_Glass

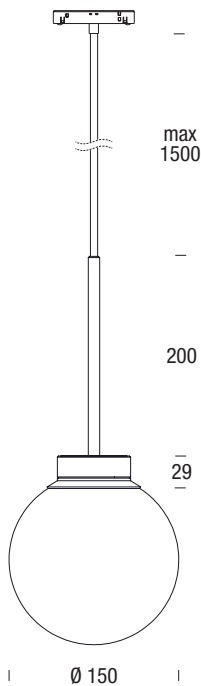

Power	Lumen output	Code to complete *
9,5 W	560 lm	CC-S ■ ▲ ❖

◆ 48Vdc | IP20

CRI>80 | RG0 | SCDM<3 - UP to 59 lm/W | L80/B20 60.000 h.
Lumen output values: luminaire luminous flux at 4000 K

*** Select your option**

Colour		CCT		Control	
Nero	B	2700 K	1	On/Off	NV
		3000 K	2	DALI	DV
		4000 K	3		

TRACK LIGHTING

ACE / ACOUSTIC_Led

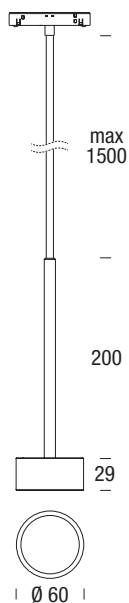

Power	Lumen output	Code to complete *
9,5 W	700 lm	CB-SB ■ ▲ ❖

◆ 48Vdc | IP20

CRI>80 | RG0 | SCDM<3 - UP to 73 lm/W | L80/B20 60.000 h.
Lumen output values: luminaire luminous flux at 4000 K

* Select your option

Colour		CCT		Control	
Nero	B	2700 K	1	On/Off	NV
		3000 K	2	DALI	DV
		4000 K	3		

CALOTTA

Description		Code to complete *
Calotta	Ø 450_H.80	BSS01A ❖
	Ø 600_H.154	BSS01B ❖



* Select your option

Colour	
Grigio / Grey	G
Blu / Blue	B
Rosso / Red	R
Verde / Green	Y

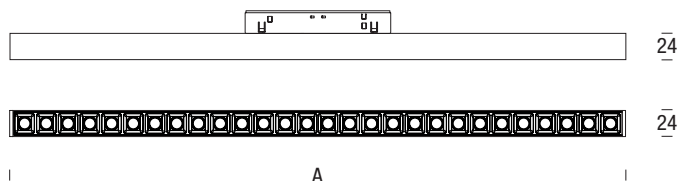

MAYA_MICRO

Downlight

Model	Power	Lumen output	Dimension	Code to complete *
300	5 W	695 lm	287 mm	ZM-TD ● ■ △ ☺ ☐
600	10 W	1390 lm	566 mm	ZM-TE ● ■ △ ☺ ☐
900	15 W	2100 lm	846 mm	ZM-TF ● ■ △ ☺ ☐

◆ 48Vdc | IP20

UP to 139 lm/W | UP to UGR≥16 | L80/B20 80.000 h. | CRI>90 | UP to RG0 | SDCM<3
Lumen output values: luminaire luminous flux at 4000 K - optics 30°

*** Select your option**

Colour adapter ●	CCT ■	Optic △	Control ☺	Structure colour ☐
Bianco W	2700 K 1	30° Bianco A	On/Off NV	Bianco WW
Nero B	3000 K 2	30° Nero B	DALI DV	Nero BB
	4000 K 3	55° Bianco C		
		55° Nero D		
		120° E		
		Micro M		



**SICURO/
ELEGANTE/
VERSATILE/**

TWENTY

COLLECTION





TWENTY

COLLECTION

IT_20 millimetri è il diametro del sistema luminoso Twenty. Una proposta ricca di soluzioni, tecnologie, finiture e modelli utilizzabili nell'illuminazione residenziale contemporanea. Linee sottili, cura del dettaglio, estetica raffinata, ampia scelta di colori e modelli. In gamma troviamo lampade da terra dimmerabili, sospensioni orizzontali e verticali, apparecchi da parete e soffitto. Twenty, in ogni declinazione, esprime carattere e stile. Un gioiello assoluto capace di qualificare l'ambiente in cui viene installato.

EN_20 mm is the diameter of the light system Twenty. A wide proposal in solutions, technologies, finishes and models easy to use in contemporary residential lighting. Fine lines, attention to detail, refined aesthetics, wide choice of colors and patterns. The range includes dimmable floor lamps, horizontal and vertical suspensions, wall and ceiling luminaires. Twenty, in every version, expresses character and style. An absolute jewel capable of qualifying the environment in which it is installed.



20 mm



**SOSPENSIONE/
SOFFITTO/
PARETE/
TESATA VERTICALE/
DA TERRA/**

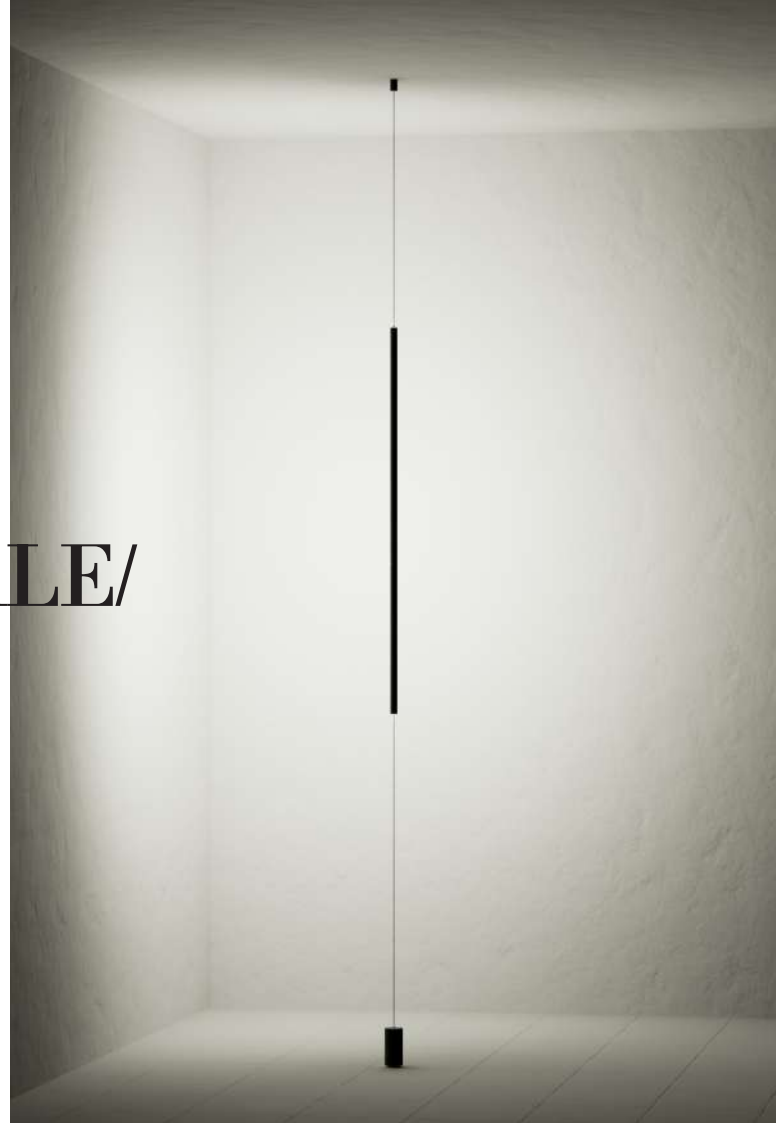

Sospensione

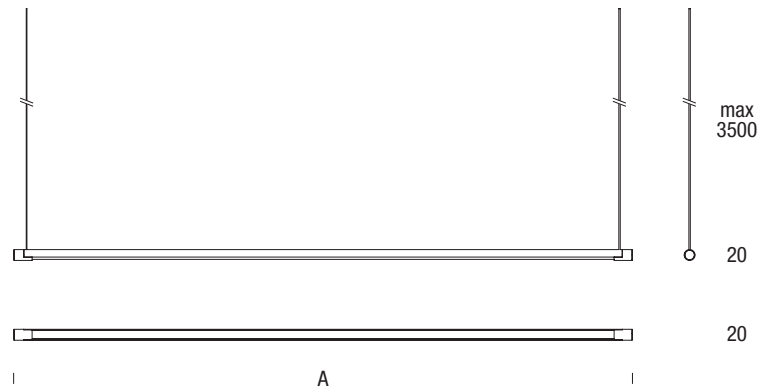

Model	Power	Lumen output	Dimension A	Code to complete *
1100	20 W	1620 lm	1184 mm	VS-AA ■ ▲
1700	34 W	2754 lm	1743 mm	VS-AB ■ ▲
2200	40 W	3240 lm	2302 mm	VS-AC ■ ▲

◆ 24Vdc | IP40

UP to 81 lm/W | opal diffuser | L70/B50 > 36.000 h. | CRI>90 | RG0
Lumen output values: luminaire luminous flux at 4000 K

* Select your option

CCT	Colour
2700 K 1	Bianco WW
3000 K 2	Nero BB
4000 K 3	Grigio lunare GG
	Champagne EE
	Tabacco OO

ACCESSORI

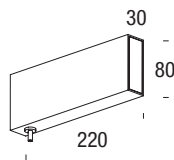

Description	Code to complete *
Rosone 220-240Vac, alimentatore incluso	VSS02 ● ■
Incasso 220-240Vac, alimentatore incluso	VSS04 ● ■

* Select your option

Colour	Control
Bianco W	On/Off NF
Nero B	DALI DA
	Push PU

TWENTY

Sospensione Verticale

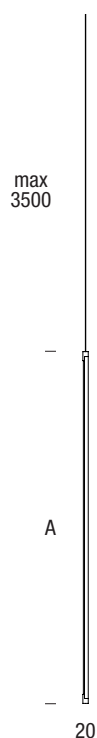

Model	Power	Lumen output	Dimension A	Code to complete *
600	10 W	883 lm	665 mm	VR-BF ■ ▲
900	16 W	1325 lm	887 mm	VR-BG ■ ▲
1100	20 W	1620 lm	1136 mm	VR-BA ■ ▲

◆ 24Vdc | IP40

UP to 81 lm/W | opal diffuser | L70/B50 > 36.000 h. | CRI>90 | RG0
Lumen output values: luminaire luminous flux at 4000 K

* Select your option

CCT		Colour	
2700 K	1	Bianco	WW
3000 K	2	Nero	BB
4000 K	3	Grigio lunare	GG
		Champagne	EE
		Tabacco	OO

ACCESSORI

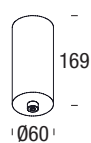

Description	Code to complete *
Rosone 220-240Vac, alimentatore incluso ⊕	VSS03 ● NF
Incasso 220-240Vac, alimentatore incluso □	VSS04 ● ■

* Select your option

Colour		Control	
Bianco	W	On/Off	NF
Nero	B	DALI	DA
		Push	PU

Tesata Verticale

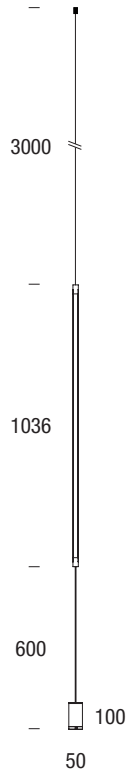

Dimmer a pedale con memoria
Foot dimmer with memory

Model	Power	Lumen output	Code to complete *
1100	20 W	1620 lm	VV-BA ■ ▲

□ 220÷240Vac | IP40

UP to 81 lm/W | opal diffuser | L70/B50 > 36.000 h. | CRI>90 | RGO
Lumen output values: luminaire luminous flux at 4000 K

* Select your option

CCT	■	Colour	▲
2700 K	1	Bianco	WW
3000 K	2	Nero	BB
4000 K	3	Grigio lunare	GG
		Champagne	EE
		Tabacco	OO

TWENTY

Parete

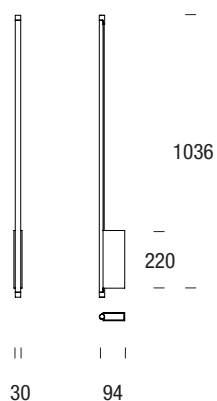

Model	Power	Lumen output	Code to complete *
1100	20 W	1620 lm	VW-BA ■ ■ ■ △

□ 220÷240Vac | IP40

UP to 81 lm/W | opal diffuser | L70/B50 > 36.000 h. | CRI>90 | RGO
Lumen output values: luminaire luminous flux at 4000 K

* Select your option

CCT	■	Control	■■	Colour	△
2700 K	1	On/Off	NF	Bianco	WW
3000 K	2	DALI	DA	Nero	BB
4000 K	3			Grigio lunare	GG
				Champagne	EE
				Tabacco	00

Plafone/Parete

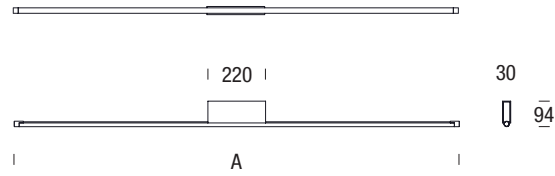

Diretta

Model	Power	Lumen output	Dimension A	Code to complete *
1700	34 W	2754 lm	1636 mm	VC-AB ■ :: △

Riflessa

1700	27 W	2187 lm	1636 mm	VC-BB ■ :: △
------	------	---------	---------	---------------------

220÷240Vac | IP40

UP to 81 lm/W | opal diffuser | L70/B50 > 36.000 h. | CRI>90 | RG0
Lumen output values: luminaire luminous flux at 4000 K

* Select your option

CCT	Control	Colour
2700 K 1	On/Off NF	Bianco WW
3000 K 2	DALI DA	Nero BB
4000 K 3		Grigio lunare GG
		Champagne EE
		Tabacco OO

TWENTY

Da Terra

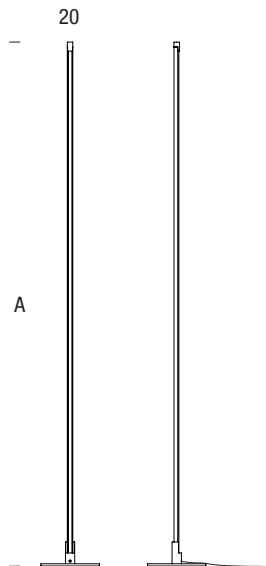

Dimmer a pedale con memoria
Foot dimmer with memory

Model	Power	Lumen output	Dimension A	Code to complete *
1900	38 W	3078 lm	1900 mm	VE-OD ■ ▲
2400	44 W	3564 lm	2400 mm	VE-OE ■ ▲

□ 220÷240Vac | IP40

UP to 81 lm/W | opal diffuser | L70/B50 > 36.000 h. | CRI>90 | RGO
Lumen output values: luminaire luminous flux at 4000 K

* Select your option

CCT	Colour
2700 K 1	Bianco WW
3000 K 2	Nero BB
4000 K 3	Grigio lunare GG
	Champagne EE
	Tabacco OO

BASE



| 215 |

Description	Code to complete *
Base	VE-P ■■

Base colour	
Bianco	WW
Nero	BB
Grigio lunare	GG
Champagne	EE
Tabacco	OO

MAYA_MICRO

COLLECTION

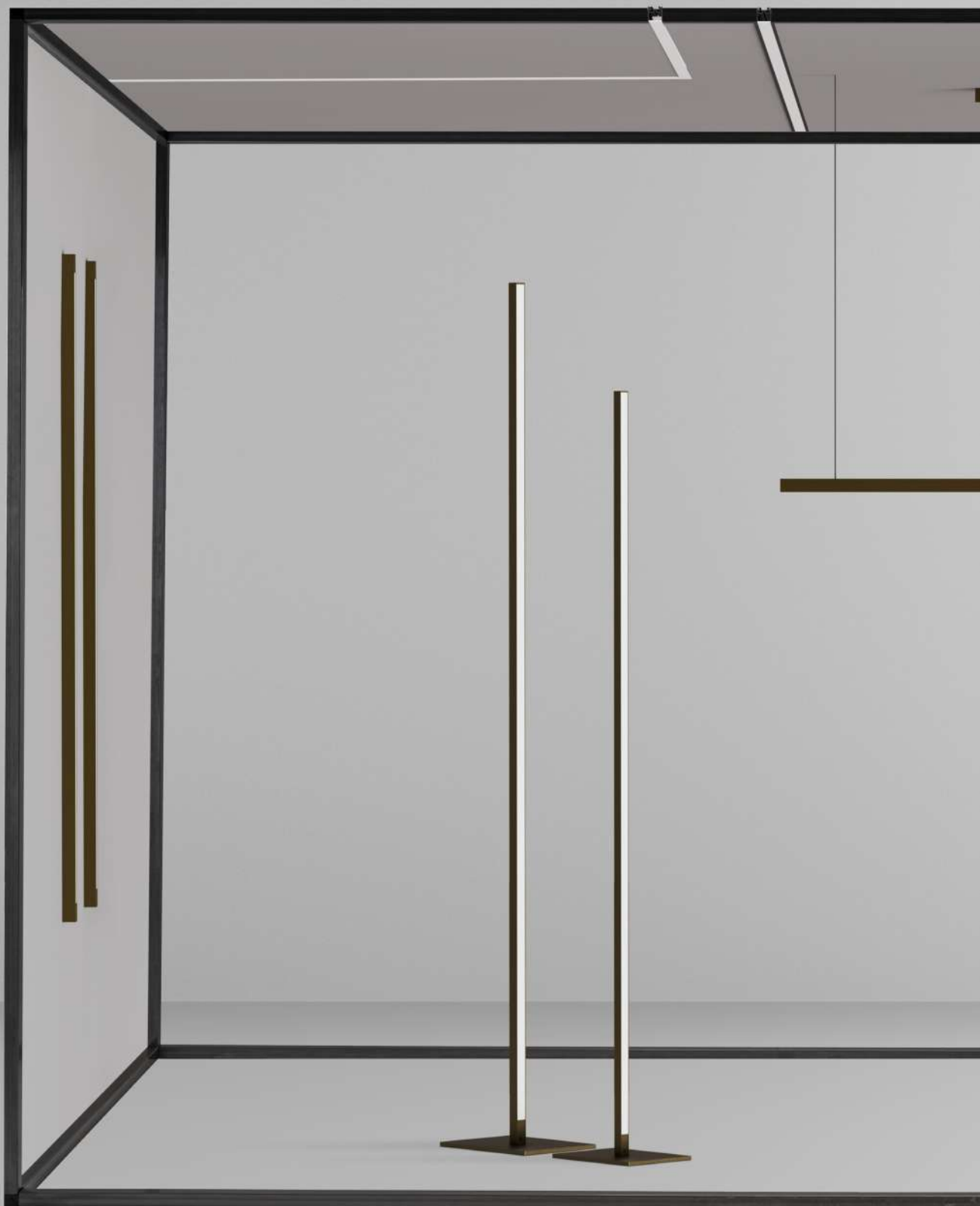



MAYA_MICRO

COLLECTION

IT_ La nuova generazione del profilo Maya_Micro minimizza le dimensioni e raggiunge livelli di efficienza elevatissimi. Presentiamo una gamma completa per applicazioni, sviluppi, colori e tecnologie. Affidabilità, qualità costruttiva e cura del dettaglio, sono i criteri che animano la nostra proposta.

EN_ The new generation of the Maya_Micro profile minimizes dimensions and achieves very high efficiency levels. We present a complete range for applications, developments, colors and technologies. Reliability, construction quality and attention to detail are the criteria that animate our proposal.



SOSPENSIONE/ SOFFITTO/ PARETE/ INCASSO/ DA TERRA/

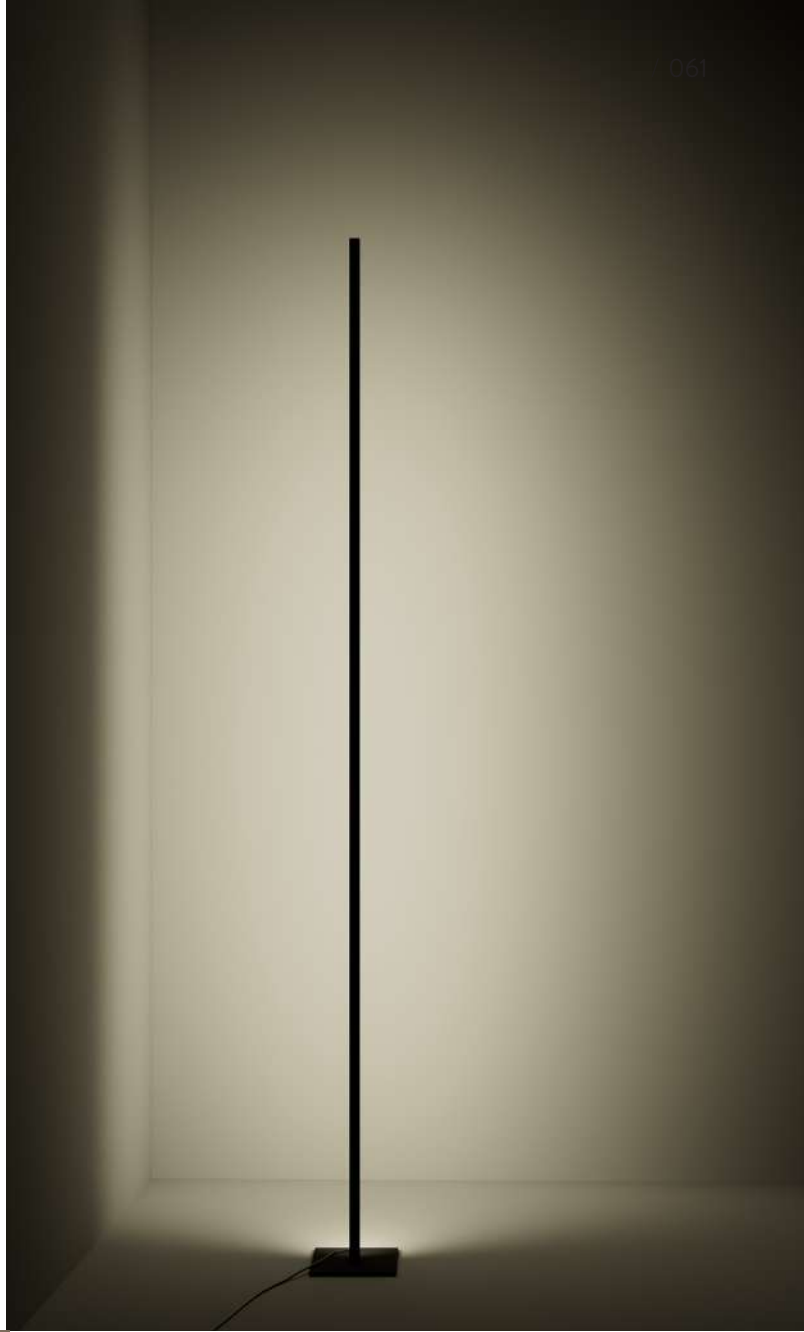

IT_ L'illuminazione d'interni trova nuovi spunti con MAYA_MICRO: lampade da terra, sospensioni, apparecchi da parete e soffitto, gruppi da incasso sono l'asse portante della gamma. Diverse le varianti per misure, potenze, colori, ottiche e gestioni. Le dimensioni estremamente contenute accentuano l'efficienza del prodotto. Schede Led ed ottiche con prestazioni di vertice classificano MAYA MICRO nella fascia alta del mercato.

EN_ Interior lighting take new inspiration with MAYA_MICRO: floor lamps, suspensions, wall and ceiling luminaires, recessed units are the backbone of the range. Several variants for sizes, powers, colors, optics and management. The extremely small dimensions accentuate the efficiency of the product. Led and optical cards with top performance rank MAYA MICRO in the high end of the market.

MAYA_MICRO

COLLECTION



Sospensione_24

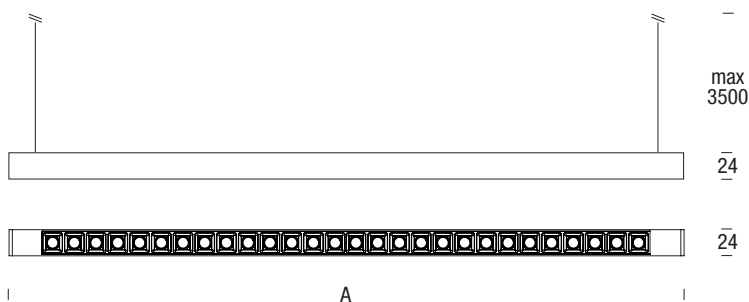

Diretta

Model	Power	Lumen output		Dimension A	Code to complete *
		downlight	uplight		
1100	20 W	2780 lm	-	1184 mm	ZM-SAG ■ △ □
1700	30 W	4170 lm	-	1743 mm	ZM-SAI ■ △ □
2200	40 W	5560 lm	-	2302 mm	ZM-SAL ■ △ □

◆ Moduli SELV (V < 60 V) | IP40

UP to 139 lm/W | UP to UGR≥16 | L80/B20 80.000 h. | CRI>90 | UP to RG0 | SDCM<3
Lumen output values: luminaire luminous flux at 4000 K - optics 30°

* Select your option

CCT	Optic	Structure colour
2700 K 1	30° Bianco A	Bianco WWW
3000 K 2	30° Nero B	Nero BBB
4000 K 3	55° Bianco C	Grigio lunare GGG
	55° Nero D	Tabacco 000
	120° E	Champagne EEE
	Micro M	

ALIMENTAZIONE

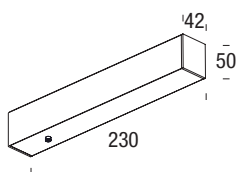

Description	Code to complete *
Rosone 220-240Vac, alimentatore incluso	ZSS021 ● ●
Rosone 220-240Vac, alimentatore incluso Solo: 2200 / Only: 2200	ZSS022 ● ●

* Select your option

Colour	Control
Bianco W	On/Off NF
Nero B	DALI DA
Grigio lunare G	Push PU
Tabacco O	
Champagne E	



Incasso 220-240Vac, alimentatore incluso	ZSS041 ○ ◇
Incasso 220-240Vac, alimentatore incluso Solo: 2200 / Only: 2200	ZSS042 ○ ◇

* Select your option

Colour	Control
Bianco W	On/Off NF
Nero B	DALI DA
	Push PU

Sospensione_30

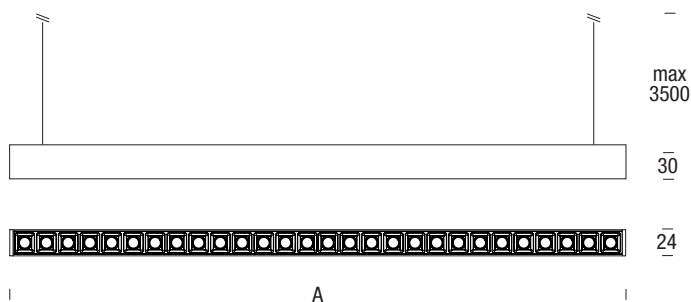

Diretta

Model	Power	Lumen output		Dimension	Code to complete	*
		downlight	uplight			
1100	20 W	2780 lm	-	1125 mm	ZM-RAG	■ ▲ □
1700	30 W	4170 lm	-	1684 mm	ZM-RAI	■ ▲ □
2200	40 W	5560 lm	-	2243 mm	ZM-RAL	■ ▲ □

◆ Moduli SELV (V < 60 V) | IP40 UP to 139 lm/W | UP to UGR≥16 | L80/B20 80.000 h. | CRI>90 | UP to RG0 | SDCM<3
Lumen output values: luminaire luminous flux at 4000 K - optics 30°

* Select your option

CCT	Optic	Structure colour
2700 K 1	30° Bianco A	Bianco WW
3000 K 2	30° Nero B	Nero BB
4000 K 3	55° Bianco C	Grigio lunare GG
	55° Nero D	Tabacco OO
	120° E	Champagne EE
	Micro M	

ALIMENTAZIONE

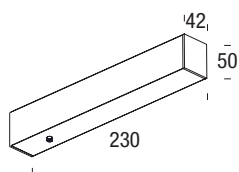

Description	Code to complete*
Rosone 220-240Vac, alimentatore incluso	ZSS021 ● ●
Rosone 220-240Vac, alimentatore incluso Solo: 2200 / Only: 2200	ZSS022 ● ●

* Select your option

Colour	Control
Bianco W	On/Off NF
Nero B	DALI DA
Grigio lunare G	Push PU
Tabacco O	
Champagne E	



Description	Code to complete*
Incasso 220-240Vac, alimentatore incluso	ZSS041 ○ ◇
Incasso 220-240Vac, alimentatore incluso Solo: 2200 / Only: 2200	ZSS042 ○ ◇

* Select your option

Colour	Control
Bianco W	On/Off NF
Nero B	DALI DA
	Push PU

MAYA_MICRO

Sospensione_30



Diretta/Indiretta

Model	Power	Lumen output		Dimension	Code to complete *
		downlight	uplight		
1100	20+10 W	2780 lm	850 lm	1125 mm	ZM-RBG ■ ▲ □
1700	30+10 W	4170 lm	850 lm	1684 mm	ZM-RBI ■ ▲ □
2200	40+20 W	5560 lm	1700 lm	2243 mm	ZM-RBL ■ ▲ □

◆ Moduli SELV (V < 60 V) | IP40

UP to 139 lm/W | UP to UGR≥16 | L80/B20 80.000 h. | CRI>90 | UP to RG0 | SDCM<3
Lumen output values: luminaire luminous flux at 4000 K - optics 30°

* Select your option

CCT	Optic	Structure colour
2700 K 1	30° Bianco A	Bianco WW
3000 K 2	30° Nero B	Nero BB
4000 K 3	55° Bianco C	Grigio lunare GG
	55° Nero D	Tabacco OO
	120° E	Champagne EE
	Micro M	

ALIMENTAZIONE

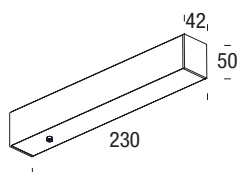

Description	Code to complete *
Rosone 220-240Vac, alimentatore incluso (2X_Solo: 2200 / Only: 2200)	ZSS021 ● ☹

* Select your option

Colour	Control
Bianco W	On/Off NF
Nero B	DALI DA
Grigio lunare G	Push PU
Tabacco O	
Champagne E	



Description	Code to complete *
Incasso 220-240Vac, alimentatore incluso (2X_Solo: 2200 / Only: 2200)	ZSS041 ○ ◇

* Select your option

Colour	Control
Bianco W	On/Off NF
Nero B	DALI DA
	Push PU

Soffitto/Parete 24

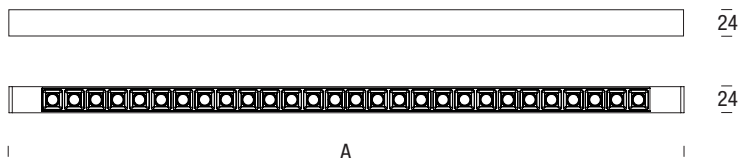

Diretta

Model	Power	Lumen output	Dimension	Code to complete*
300	5 W	695 lm	346 mm	ZM-CAD ■ ▲ □
600	10 W	1390 lm	625 mm	ZM-CAE ■ ▲ □
900	15 W	2085 lm	901 mm	ZM-CAF ■ ▲ □
1100	20 W	2780 lm	1184 mm	ZM-CAG ■ ▲ □
1400	25 W	3475 lm	1463 mm	ZM-CAH ■ ▲ □

◆ Moduli SELV (V < 60 V) | IP40

UP to 139 lm/W | UP to UGR≥16 | L80/B20 80.000 h. | CRI>90 | UP to RG0 | SDCM<3
Lumen output values: luminaire luminous flux at 4000 K - optics 30°

* Select your option

CCT	■	Optic	▲	Structure colour	□
2700 K	1	30° Bianco	A	Bianco	WWW
3000 K	2	30° Nero	B	Nero	BBB
4000 K	3	55° Bianco	C	Grigio lunare	GGG
		55° Nero	D	Tabacco	000
		120°	E	Champagne	EEE
		Micro	M		

ALIMENTAZIONE

Description	Code to complete
Alimentatori	SLE0164
220-240Vac, alimentatore incluso	SLE0166

Da Terra

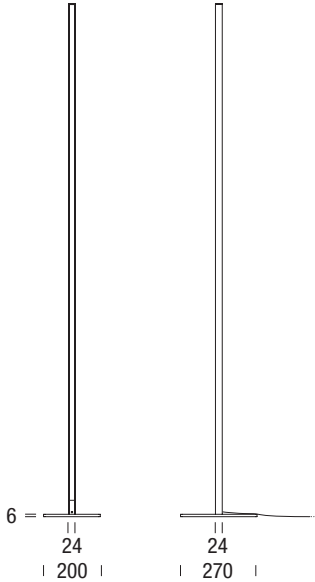

Dimmer a pedale con memoria
Foot dimmer with memory

Model	Power	Lumen output	Code to complete *
1900	34 W	2486 lm	ZM-EON ■ ▲ □ ●
2400	48 W	3552 lm	ZM-E00 ■ ▲ □ ●

□ 220÷240Vac | IP40

UP to 74 lm/W | opal diffuser | L70/B50 > 36.000 h. | CRI>90 | RG0
Lumen output values: luminaire luminous flux at 4000 K

* Select your option

CCT	■	Optic	▲	Control	□	Structure colour	●
2700 K	1	120°	E	Dimmer	DM	Bianco	WW
3000 K	2			Voice Control Tuya + RF	TU	Nero	BB
4000 K	3					Grigio lunare	GG
Tunable **	4					Tabacco	OO
						Champagne	EE

** Solo/Only: Voice Control Tuya + RF

BASE



Description	Code to complete *
Base	ZM-EP ■■

Base colour	■■
Bianco	WW
Nero	BB
Grigio lunare	GG
Tabacco	OO
Champagne	EE

Incasso_Trimmed

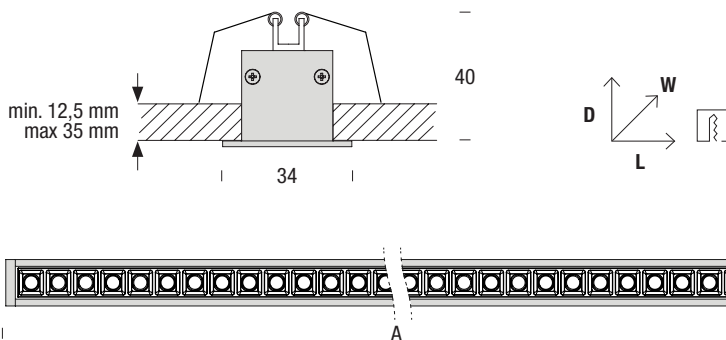

Diretta

Model	Power	Hole size (mm)			Dimension A	Lumen output	Code to complete *
		Width	Length	Depth			
60	4 W	26	66	90	75 mm	504 lm	ZM-AA ■ △ □
120	7 W	26	126	90	134 mm	882 lm	ZM-AB ■ △ □
180	10 W	26	186	90	194 mm	1260 lm	ZM-AC ■ △ □
300	5 W	26	286	90	295 mm	695 lm	ZM-AD ■ △ □
600	10 W	26	566	90	574 mm	1390 lm	ZM-AE ■ △ □
1100	20 W	26	1127	90	1133 mm	2780 lm	ZM-AG ■ △ □
600x600	20 W	-	-	-	Optic 573x594 120°/Micro 585x585	2780 lm	ZM-AM ■ △ □

◆ Moduli SELV (V < 60 V) | IP40

UP to 139 lm/W | UP to UGR≥16 | L80/B20 80.000 h. | CRI>90 | UP to RG0 | SDCM<3
Lumen output values: luminaire luminous flux at 4000 K - optics 30°

* Select your option

CCT	Optic	Structure colour
2700 K 1	30° Bianco A	Bianco WW
3000 K 2	30° Nero B	Nero BB
4000 K 3	55° Bianco C	
	55° Nero D	
	120° E	
	Micro M	

ALIMENTAZIONE

Description	Code to complete
Alimentatori	
On/Off	SLE0164
220-240Vac, alimentatore incluso	DALI/PUSH SLE0166
<input type="checkbox"/>	

ACCESSORI

Description	Code
Staffa giunzione meccanica	ZSS03303

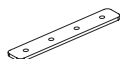

MAYA_MICRO

Incasso_Trimless

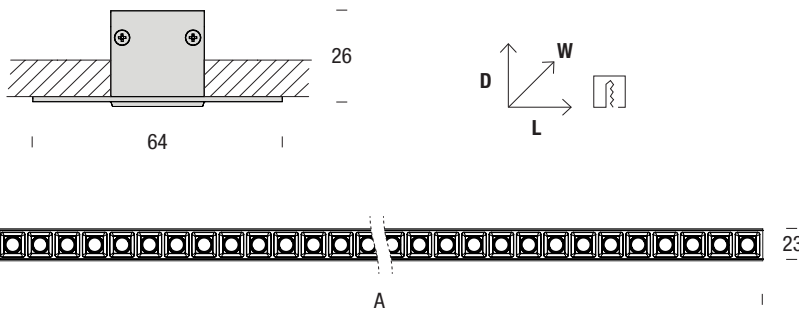

Diretta

Model	Power	Hole size (mm)			Dimension A	Lumen output	Code to complete *
		Width	Length	Depth			
60	4 W	28	68	30	60 mm	504 lm	ZM-BA ■ ▲ □
120	7 W	28	128	30	120 mm	882 lm	ZM-BB ■ ▲ □
180	10 W	28	188	30	180 mm	1260 lm	ZM-BC ■ ▲ □
300	5 W	28	288	30	280 mm	695 lm	ZM-BD ■ ▲ □
600	10 W	28	568	30	560 mm	1390 lm	ZM-BE ■ ▲ □
1100	20 W	28	1125	30	1119 mm	2780 lm	ZM-BG ■ ▲ □
600x600	20 W	-	-	-	Optic 559x579 120°/Micro 561x561	2780 lm	ZM-BM ■ ▲ □

◆ Moduli SELV (V < 60 V) | IP40

UP to 139 lm/W | UP to UGR≥16 | L80/B20 80.000 h. | CRI>90 | UP to RG0 | SDCM<3
Lumen output values: luminaire luminous flux at 4000 K - optics 30°

* Select your option

CCT ■	Optic ▲	Structure colour □
2700 K 1	30° Bianco A	Bianco WW
3000 K 2	30° Nero B	Nero BB
4000 K 3	55° Bianco C	
	55° Nero D	
	120° E	
	Micro M	

ALIMENTAZIONE

Description	Code to complete
Alimentatori On/Off	SLE0164
220-240Vac, alimentatore incluso DALI/PUSH	SLE0166



ACCESSORI

Description	Code
Staffa giunzione meccanica	ZSS03303

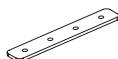

Concept and Design
Studio grafico PAN

© 2024



PAN Srl
Via G. Michelucci 1
50028 Barberino Tavarnelle
Firenze, Italy

Information
Tel. +39 055 8059336
Fax +39 055 8059338
panint@panint.it
export@panint.it
panint.it



archiproducts®

